

# RIDE, GAME & ACTIVITY PROSPECTUS 2021

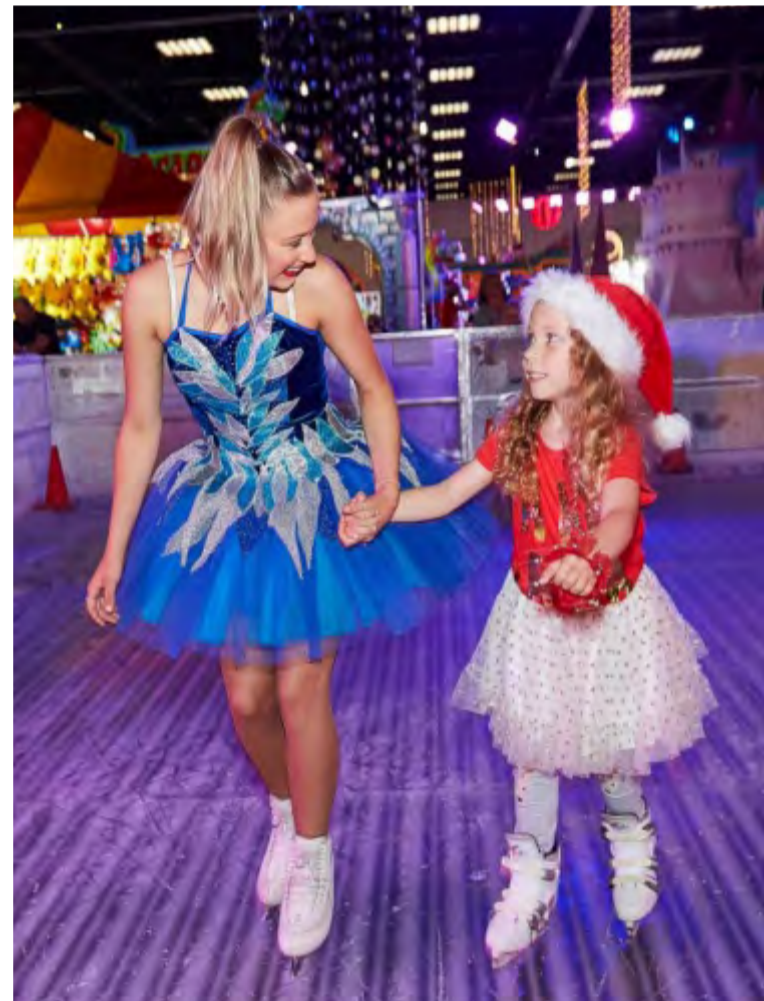



## Introduction

With just one phone call you have all the requirements for your Party or School Fete. Instead of having to source all your equipment from multiple suppliers to obtain the best price, we do it all for you. Less stress plus time and money saved.

We do the delivery and pick up as well providing a staff member to oversee the loading and unloading and assist you with the set up. All you need to provide is a group to manage the set up and dismantling.

The normal cost of hiring equipment would be expensive without transport to & from the event or a staff member to oversee the setup.

If, however, you put together a list of equipment that exceeds \$3,750 you'll get free delivery & pick up with an assisting ASA staff member.

Our Equipment Selection Includes:

- Electrical Leads & 3 Phase Power Boxes,
- Chairs & Trestle Tables,
- Coloured Flags,
- Poles & Pegs,
- Children's Bouncy Castles,
- Fairground Games,
- Thrill & Family Rides,
- Children's Activities,
- Coffee, Fairy Floss & Popcorn Machines,
- BBQs, Bain-maries, Slushie Machines
- Umbrellas, Tents & Marquees, and
- Flood Lighting.

No school fete would be complete without traditional "carnival" fare. We can help you with anything from fairy floss, potato vans, coffee carts through to the provision of a quality food canteen.

If you prefer to arrange your own catering, we can also provide you with the equipment needed such as BBQs, deep fryers, bay marie, donut maker, spit roast machines and much, much more.

# About Us

**ASA is owned** and operated by **Russell and Amanda Watkins**. Russell is a 4th generation amusement provider following proudly in his grandfathers footsteps and Amanda & Russell are the co-creators and driving force behind **Adelaide's premier Christmas event Santa's Wonderland!**

Under their stewardship the company has grown into **a strong & credible operation** with many events & festivals to their credit.

The name **Amusement Services Australia (ASA)** was selected to represent the companies expanding nature, professionalism and corporate outlook as it continues to grow, develop and deliver new and exciting amusements to the Australian community.

**Russell & Amanda's ultimate goal** is to expand their brand to the corporate market and to move forward to a permanent amusement park model where they are recognized as a professional, reliable and reputable leader in their industry!

# Mission Statement

**Our Mission is to deliver** the latest attractions & innovative concepts that inspire our peers and amaze our patrons in a safe, happy, fun filled environment for both our staff and guests.

# Affiliations





# Where we'll be in 2021

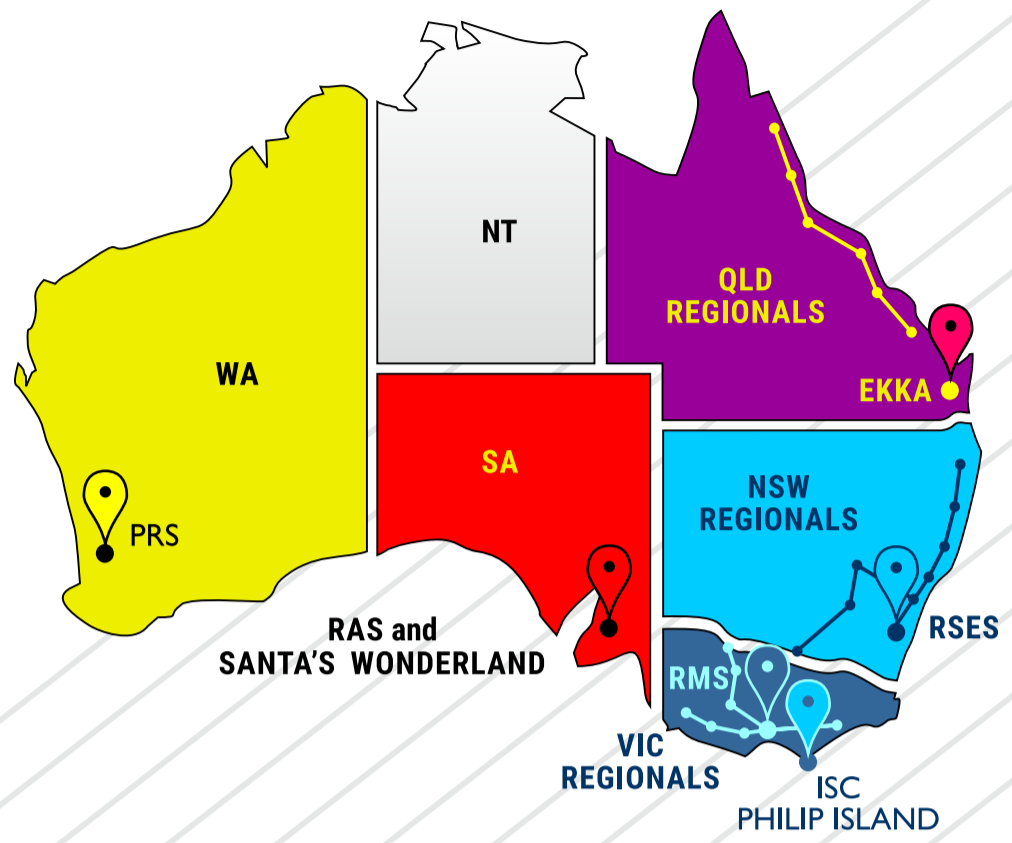

Apart from each states **capital shows** and regional events, Amusement Services Australia has created & operates **Santa's Wonderland Adelaide** & the Island Summer Carnival, Cowes, Philip Island, Victoria.

## Big "Event" Specialists

Amusement Services Australia and Amanda Watkins are **BIG EVENT** specialists!

Christmas starts early each December every year when **Santa's Wonderland** comes alive at the Adelaide Showground with an extravagant range of amazing amusement rides, spectacular Christmas Stage Shows, Ice Skating Rink, exhilarating Ice Slide & our Christmas Activity trail.

With close to **50,000 customers** through the doors each year Santa's Wonderland offers a Whole World of Christmas Magic!

Laugh, sing, dance and selfie your way through this truly magical walk through wonderland with your family and friends!

Learn more about our creation here:

[www.santaswonderland.com.au](http://www.santaswonderland.com.au)



## Table of Contents

<b>Introduction</b>	<b>02</b>
<b>About Us / Mission Statement</b>	<b>03</b>
<b>Where We'll be in 2020 / Big Event Specialists</b>	<b>04</b>
<b>Ride Specifications</b>	<b>06</b>
<b>Collage of Images</b>	<b>07</b>
<b>Spaceroller</b>	<b>18</b>
<b>Starship</b>	<b>19</b>
<b>Kamikaze</b>	<b>20</b>
<b>Midnight Madness</b>	<b>21</b>
<b>Ice Skating Rink</b>	<b>22</b>
<b>Giant Ice Slide</b>	<b>23</b>
<b>Ball Crawl</b>	<b>24</b>
<b>Dragon Wagon</b>	<b>25</b>
<b>Super Planes</b>	<b>26</b>
<b>Super Trucks</b>	<b>27</b>
<b>Motorbikes</b>	<b>28</b>
<b>Santa Fe Train</b>	<b>29</b>
<b>Dodgem Cars</b>	<b>30</b>
<b>Ocean Explorers</b>	<b>31</b>
<b>Tea Cups</b>	<b>32</b>
<b>Waterballs</b>	<b>33</b>
<b>Bungy Trampolines</b>	<b>34</b>
<b>Sea Circus Giant Slide</b>	<b>35</b>
<b>Candyland Jumping Castle 1</b>	<b>36</b>
<b>Candyland Jumping Castle 2</b>	<b>37</b>
<b>Mini Quad Dirt Bikes</b>	<b>38</b>
<b>Giant Worm</b>	<b>39</b>
<b>Shark Jumping Castle</b>	<b>40</b>
<b>Adventure Time Ring a Bottle</b>	<b>41</b>
<b>Cartoon Network Pick a Pop</b>	<b>42</b>
<b>Shopkins Catch a Character</b>	<b>43</b>
<b>Laughing Clowns</b>	<b>44</b>
<b>Bazooka Blast</b>	<b>45</b>
<b>Safety Officer / First Aid / Accreditations</b>	<b>46</b>
<b>Uniforms &amp; Presentation</b>	<b>47</b>
<b>Revenue Tracking / Contact Us</b>	<b>48</b>

# RIDE SPECIFICATIONS

Ride/Activity Name	Footprint	Capacity	Power	Assembly Time	Disassembly Time	Engineer Name	Cert Date	Reg No	Reg Exp	Design Reg	Brand	Year of Manufacture
Starship	19m x 16m x 8m	45 PAX	33Kw 3 Phase 5 Wire 220v	6 HRS	3 HRS	Tim Gibney	28/7/2019	NSW/ X1494	5/4/2021	N/A	Ferrari Australia	1980
Dragon Wagon	15m x 8.5 x 6.5m	16 PAX	32 Amp 3 Phase	2 HRS	2 HRS	Phil Britton Isis Engineering	29/7/2019	SA / S900057	8/8/2021	N/A	Wisdom Rides USA	1990
Spaceroller	22m x22m x14.5m	20 PAX	300 Amps 3 Phase	8HRS	8HRS	Tim Gibney	29/7/2019	NSW / X719105	8/8/2021	QLD / QZZ781	Mondial Holland	2000
Super Motorbikes	10m x 10m x 6m	12 PAX	12Kw 208v 3 Phase	2HRS	2HRS	Ian Thompson Engineering	29/7/2019	QLD / P0080905	8/8/2021	QLD / QZZ781	HAMPTON USA	1993
Super Trucks	8m x 8m x 3m	20 PAX	12Kw 208v 3 Phase	1HRS	1HRS	Phil Britton Isis Engineering	29/7/2019	SA / S900047	8/8/2021	N/A	SBF Italy	1999
Super Planes	8m x 8m x 4m	18 PAX	7kw 380v 3 Phase	2HRS	2HRS	Phil Britton Isis Engineering	29/7/2019	SA / S900056	24/8/2021	N/A	Zamperla Italy	1989
Bungy Trampoline	6m x 6m x 8m	6 PAX	2Kw 50v	2HRS	2HRS	N/A	N/A	N/A	N/A	N/A	ASA	2014
Sanat Fe Train	11m x 7m x 2.5m	16 PAX	2Kw 50v	2HRS	2HRS	Salesh Prasad	28/11/2019	NSW / X8845	12/5/2021	NSW / AD-6-213740/17	Modern Amusements	2016
Waterballs	15m x 10m x 2m	10 PAX	Australian Standard 230v	1 HRS	1 HRS	N/A	N/A	N/A	N/A	N/A	General Group China	2016
Ride on Reindeers	10m X 10m	25 PAX	Australian Standard 230v	1 HRS	1 HRS	N.A	N/A	N/A	N/A	N/A	General Group China	2016
Candy 1 Jumping Castle	5m x 5.5m x 4.8m	12 PAX	Australian Standard 230v	2 HRS	2 HRS	N/A	N/A	N/A	N/A	N/A	General Group China	2016
Candy 2 Jumping Castle	8.7m x 4.5m x 5.8m	12 PAX	Australian Standard 230v	2 HRS	2 HRS	N/A	N/A	N/A	N/A	N/A	General Group China	2016
Giant Inflatable Slide	5m X 10m	12 PAX	Australian Standard 230v	2 HRS	2 HRS	N/A	N/A	N/A	N/A	N/A	General Group China	2016
Xmas Jumping Castle	5m x 5m x 3m	12 PAX	Australian Standard 230v	2 HRS	2 HRS	N/A	N/A	N/A	N/A	N/A	General Group China	2016
Ball Crawl	12m x 12m x 4.5m	12 PAX	Australian Standard 230v	2 HRS	1 HRS	N/A	N/A	N/A	N/A	N/A	General Group China	2017
Ice Rink	14m x 25m x 1.5m	N/A	See Attached Specifications	24 HRS	1 HRS	N/A	N/A	N/A	N/A	N/A	Industrial Frigo	2018
Giant Ice Slide	3m x 25m x 4.5m	2 PAX	See Attached Specifications	24 HRS	1 HRS	N/A	N/A	N/A	N/A	N/A	Industrial Frigo	2018



# Spaceroller

ASA's Premier Big Thrill Ride



# Dodgem Cars



Tea Cups



Motorbikes



Ocean Explorers



Motorbikes



Dodgem Cars





# Starship



# Dodgegem Cars



# Bungee Trampolines



# Motorbikes



# Super Trucks

# Giant Sea Circus Slide



# Super Trucks



# Super Trucks



# Waterballs



# Christmas Jumping Castle



# Candyland Jumping Castle



# Dragon Wagon

Teacups



Candyland Jumping Castle

Candyland Jumping Castle

Ball Crawl





Ice Skating



Ball Crawl



Giant Ice Slide

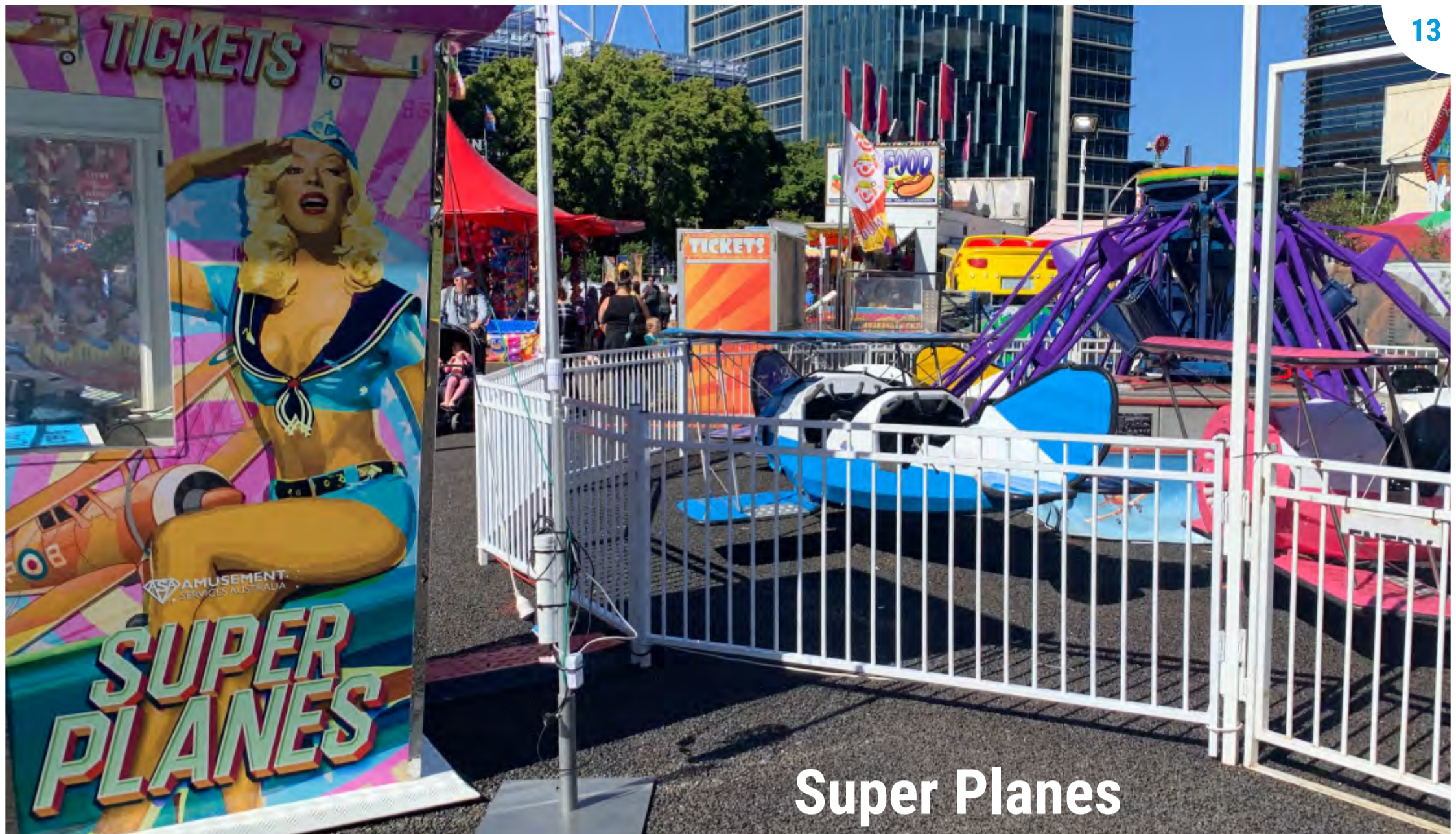

Super Planes



Motorbikes



Dodgem Cars



Ice Rink



Starship



**Giant Ice Slide**



**Super Trucks**



**Super Planes**



**Dragon Wagon**

# Kamikaze



# Spaceroller

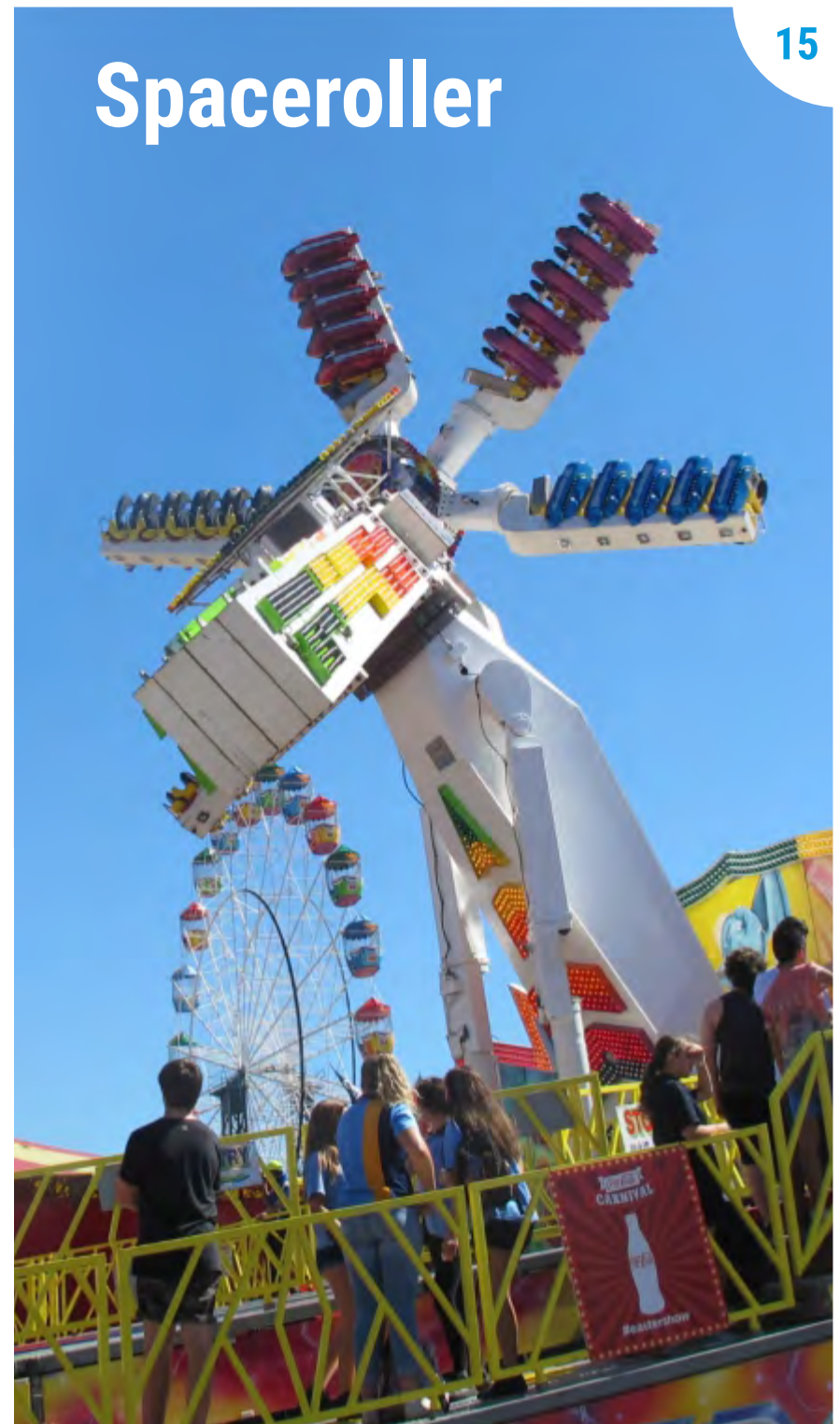

# Midnight Madness



# Dragon Wagon

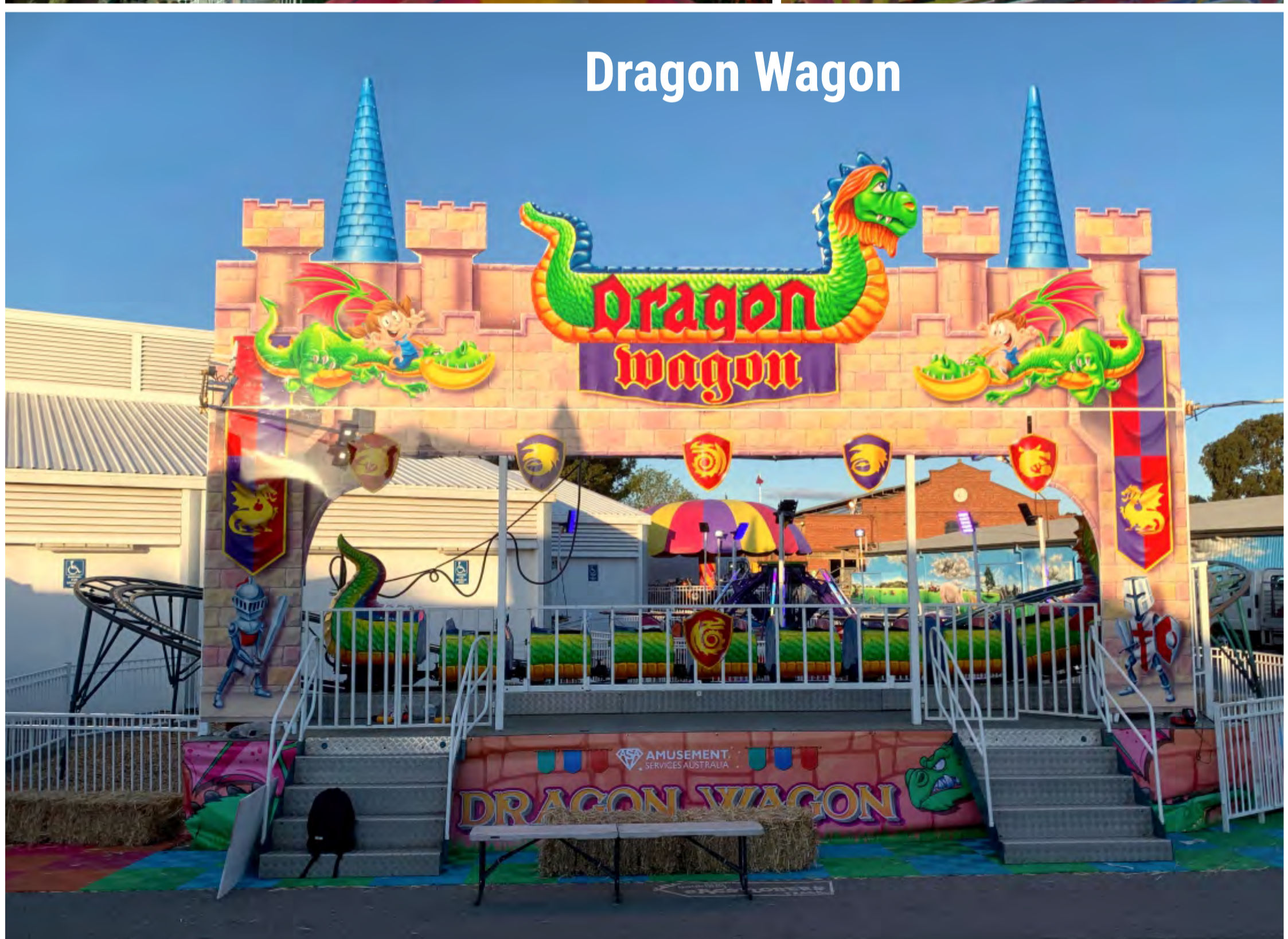

# Pick a Pop



# Ring a Bottle



# Catch a Character

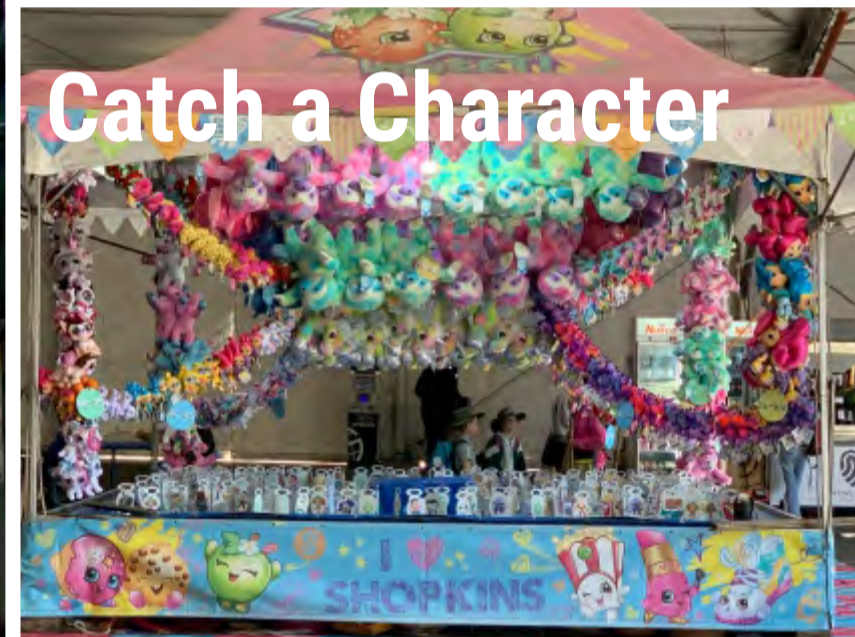





**Super Planes**



**Dragon Wagon**



**Dodgem Cars**



**Ice Skating**



**Starship**

# Spaceroller

**Also known as the Top Scan**, the Spaceroller is an amusement ride made by Mondial based in the Netherlands. It comprises 6 free-rotating gondolas each with 5 seats & the standard Mondial triple-lock harnesses which includes a redundancy safety belt!

**As the ride begins**, the main support rises upwards with the gondola arms spinning anti-clockwise and the gondolas themselves rotating freely around the arm axis, tilting upside-down. Talk about being thrown every which way but loose!

## Technical Specifications

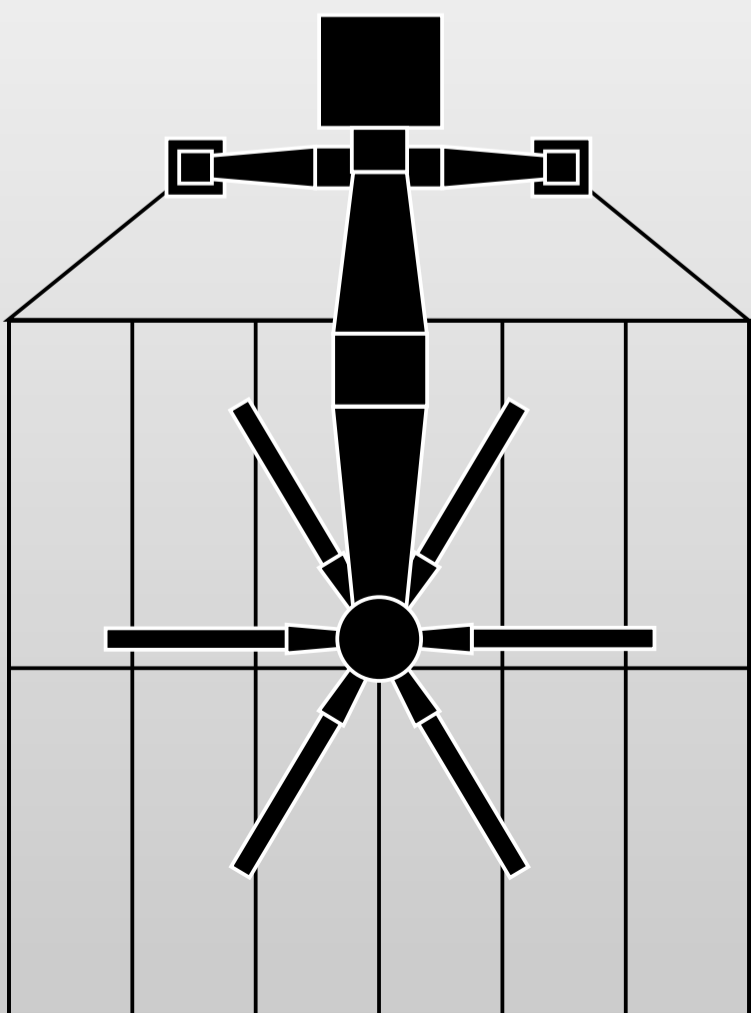
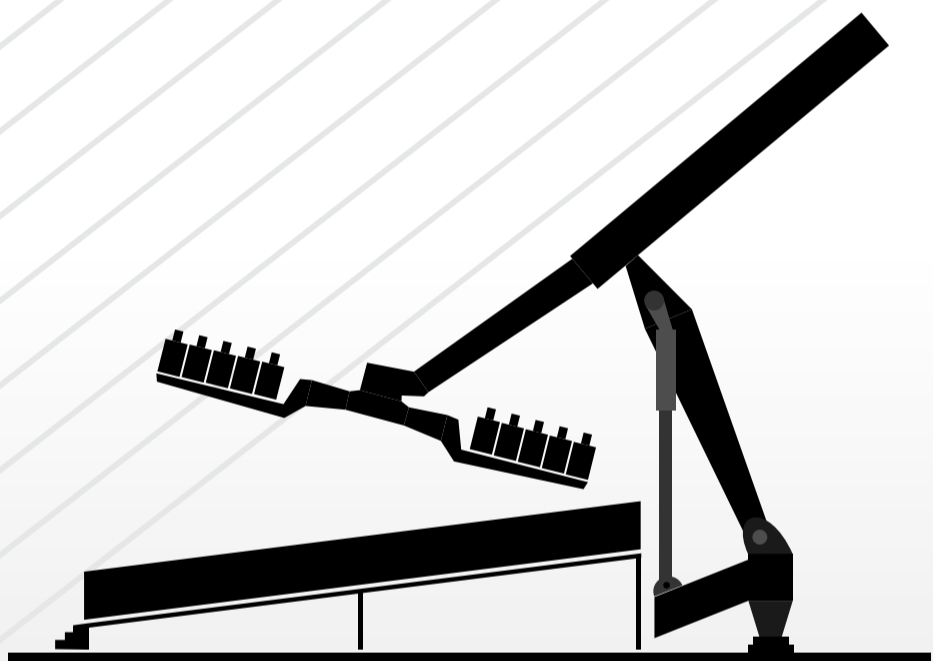

## Technical Specifications

<b>Year Of Manufacture:</b>	2000
<b>Country Of Manufacture:</b>	Netherlands
<b>Made By:</b>	Mondial
<b>Height in Full Swing:</b>	20.2 meters
<b>Lenght x Width:</b>	22 x 22 meters
<b>Cars:</b>	6 Gondola's (30 PAX)
<b>Loading:</b>	Simultaneous
<b>Estimated Capacity:</b>	600 per hour
<b>Voltage:</b>	300amps 3 Phase
<b>Frequency:</b>	50/60 Hz 2%
<b>Min Height + Age:</b>	140cm + 12 to Adult
<b>Safety:</b>	Tripple Lock Safety Bar
<b>Setup/Pulldown Times:</b>	8 Hours

# Starship

The **STARSHIP 2000** can be found in countries all over the world and was first manufactured by Wisdom USA in 1983.

The ride movement can be summed up in two words: **Centrifugal Force!** When the automated door closes the fun really begins – riders barely realise they're moving (everything they can see is moving with them).

The ride quickly starts to rotate reaching its top speed of 24 rpm in less than 20 seconds. (fast given its wide diameter).

At this speed (turned with a 33kW 3-phase motor), the **45 panels that riders** stand against rise upwards leaving people stuck to the wall with their feet off the ground.

Regular riders will always move into position as the ride gains speed, sometimes turning sideways or upside down with similar G Forces achieved from NASA training equipment.



## Technical Specifications

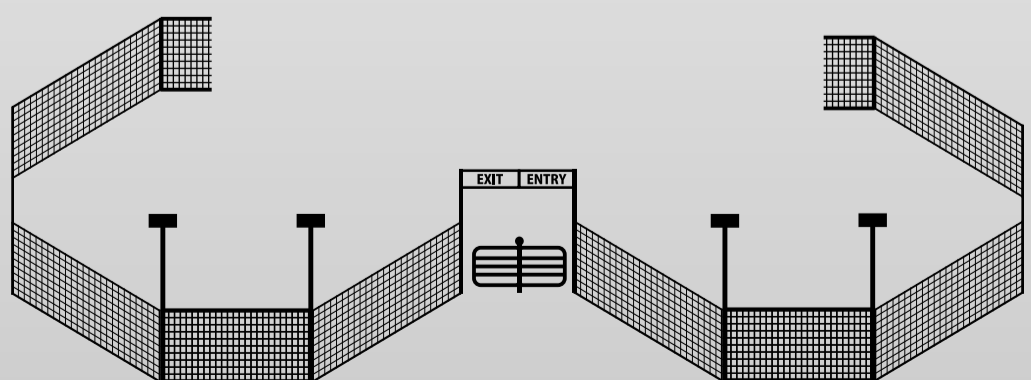
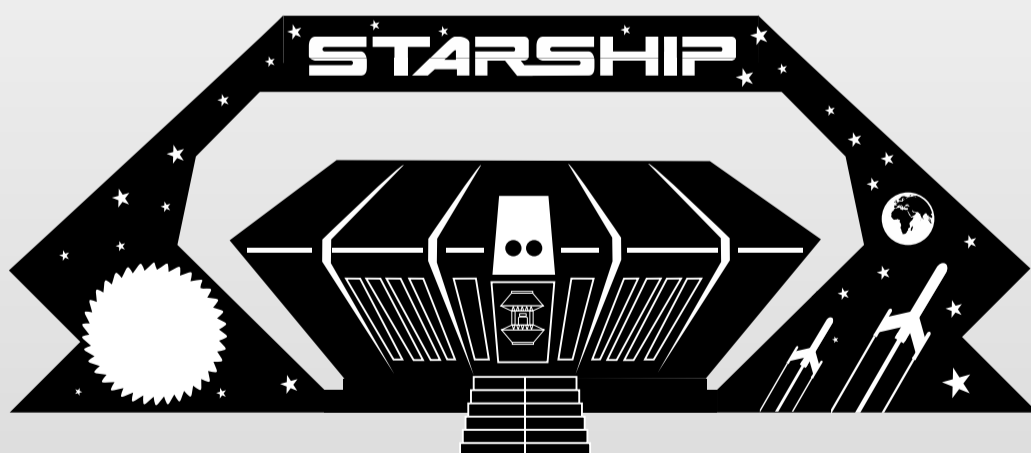

## Technical Specifications

<b>Year Of Manufacture:</b>	1980
<b>Country Of Manufacture:</b>	Australia
<b>Made By:</b>	Ferrari
<b>Height:</b>	8 meters
<b>Lenght x Width:</b>	19 x 16 meters
<b>Capacity:</b>	45 PAX
<b>Loading:</b>	Simultaneous
<b>Estimated Capacity:</b>	900 per hour
<b>Voltage/Power:</b>	33KW 3ph 5 Wire 220V
<b>Frequency:</b>	50/60 Hz 2%
<b>Min Height + Age:</b>	150cm + 12 to Adult
<b>Safety:</b>	Gravity
<b>Setup/Pulldown Times:</b>	3 Hours

# Kamikaze

The Kamikaze (AKA: Ranger) first made its debut in 1984 by Italian manufacturers Far Fabbri and Sartori.

Since this time over 150 units have been sold worldwide & similar copies have been made by almost every ride manufacturer in the industry.

**Our Kamikaze relies on a highly geared drive system** making for a very fast upside-down, pendulum motion, swinging at speeds of 13 RPM, relying on momentum to keep it swinging.

The ride movement gives feelings of **seat-pining centrifugal force** and head-rushing, blood-filling, upside-down moments varying in length, depending on the mood of the operator.

## Technical Specifications

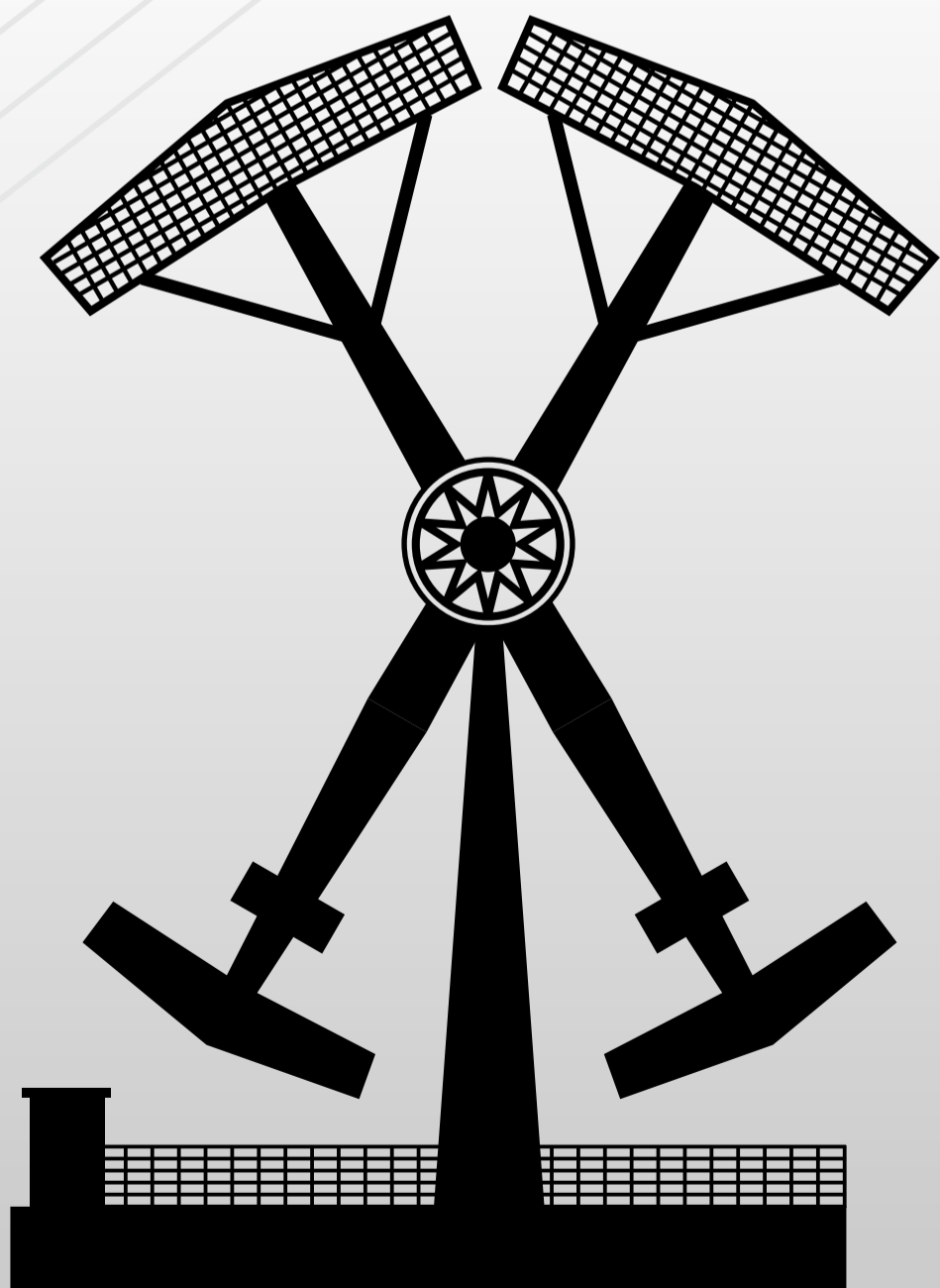

## Technical Specifications

<b>Year Of Manufacture:</b>	1985
<b>Country Of Manufacture:</b>	Italy
<b>Made By:</b>	Far Fabbri & Sartori
<b>Height:</b>	16 meters
<b>Lenght x Width:</b>	10 x 14 meters
<b>Capacity:</b>	32 PAX
<b>Loading:</b>	Simultaneous
<b>Estimated Capacity:</b>	900 per hour
<b>Voltage/Power:</b>	30KW 3ph 5 Wire 380V
<b>Frequency:</b>	50/60 Hz 2%
<b>Min Height + Age:</b>	150cm + 12 to Adult
<b>Safety:</b>	Double Lock Harness
<b>Setup/Pulldown Times:</b>	5 Hours

# Midnight Madness

Midnight Madness is another swing arm ride that gives you that sickly feeling of falling rapidly (like in a dream) without spinning you every which way but loose.

You stay seated and upright through the whole experience.

It is one of Australia's favourite family rides catering for all ages.

It is highly visible and stands out above the rest at 24m in the air. It is an exciting and robust ride which has proven popular with the public. The Midnight Madness has a signature circular motion.

## Technical Specifications

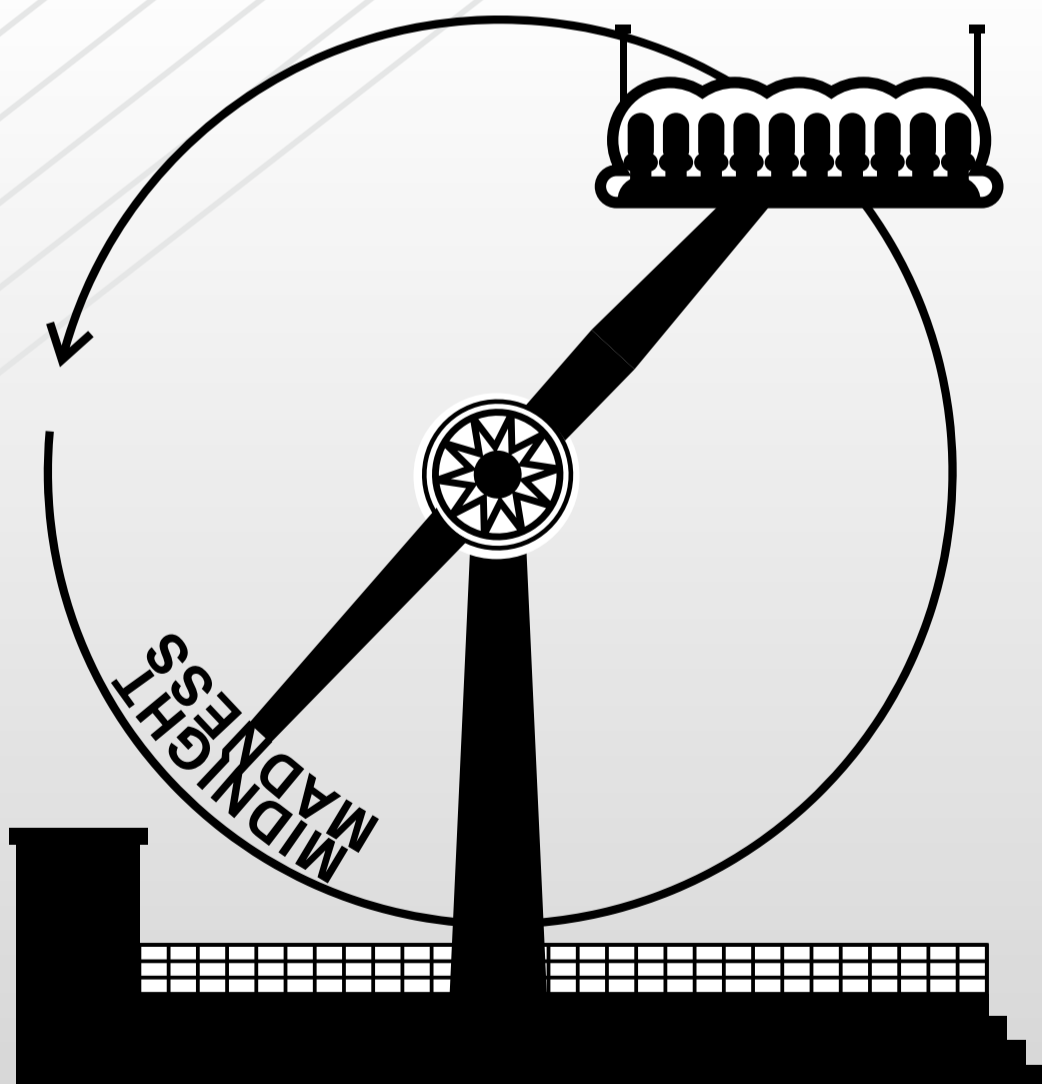

15m x 10m x 24m

## **Midnight Madness**



## Technical Specifications

<b>Year Of Manufacture:</b>	1987
<b>Country Of Manufacture:</b>	USA
<b>Made By:</b>	Wisdom
<b>Height:</b>	24 meters
<b>Lenght x Width:</b>	15 x 10 meters
<b>Capacity:</b>	22 PAX
<b>Loading:</b>	Simultaneous
<b>Estimated Capacity:</b>	250 per hour
<b>Voltage/Power:</b>	30KW 3ph 5 Wire 380V
<b>Frequency:</b>	50/60 Hz 2%
<b>Min Height + Age:</b>	120cm + 12 to Adult
<b>Safety:</b>	Double Lock Harness
<b>Setup/Pulldown Times:</b>	4 Hours

# Ice Skating Rink

Our Ice Rink is 14m in width and 25m in length. The perfect size to fit into compact indoor spaces. The rink is powered by our low noise, double gas circuit modular chillers whose specifications are listed further on in this proposal.

ASA also employs the latest technology in Ice Rink setup from floor insulation & protection to our polycarbonate, interlocking board/rail system with GRUVLOCK fittings.

Our rinks are built with LDPE, low density polyethylene, a material that combines flexibility & resistance designed & manufactured by Industrial Frigo Ice in accord to regulation DIRECTIVE97 PED / 23 / EC Module A1.

ASA uses a special type of external waterproof insulation with an elastomeric compound (BPE) and -25 C rating that allows us to install our rinks on top of any underlying material. The insulation is placed under the rink isolating the cold generated by the coils. This is great for shopping malls & convention centres protecting all kinds of flooring.



## Technical Specifications

**15m x 30m  
ICE RINK**

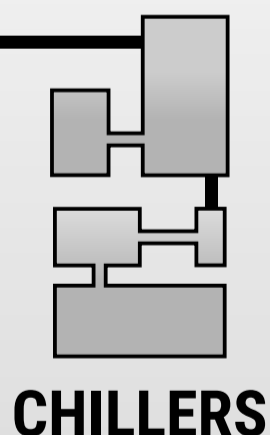

Our Rink & Chillers are made by Industrial Frigo

**SKATES**



## Technical Specifications

<b>Year Of Manufacture:</b>	2018
<b>Country Of Manufacture:</b>	Italy
<b>Made By:</b>	Industrial Frigo
<b>Height:</b>	2.5m
<b>Dimensions:</b>	15m x 30m
<b>PAX:</b>	50 Pax on the Ice
<b>Loading:</b>	Simultaneous
<b>Estimated Capacity:</b>	200 per hour
<b>Power:</b>	Lights (AUS Standard)
<b>Voltage:</b>	Lights (AUS Standard)
<b>Frequency:</b>	50/60 Hz 2%
<b>Transport:</b>	Small Semi Trailer

# Giant Ice Slide

ASA's Bungy Trampolines are a great way for children to experience the thrills of finding big air in a safe and controlled environment.

They are very easy to set up and offer hours of fun and exercise to all ages.

Bungy Trampolines are also a great way to pump up your event and your guests will love them!

Bungy Trampolines add an exciting visual element to any occasion while providing a fun, active and healthy activity that will ensure your guests will be talking about your event for a long time!

This is a favoured attraction for school fete's and smaller carnivals we organise.

## Technical Specifications

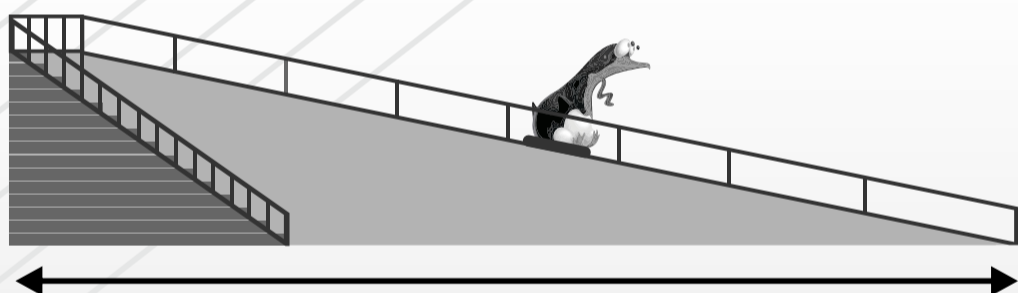

2x 1m wide, 30m Long Toboggan Slides

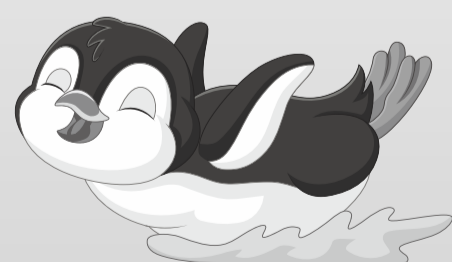

**Fun for all the Family!**



Our Slide & Chillers are made by Industrial Frigo



## Technical Specifications

<b>Year Of Manufacture:</b>	2018
<b>Country Of Manufacture:</b>	Italy
<b>Made By:</b>	Industrial Frigo
<b>Height:</b>	5 meters
<b>Dimensions:</b>	4m x 30m (not inc Chillers)
<b>PAX:</b>	Continuous Line
<b>Loading:</b>	Simultaneous
<b>Estimated Capacity:</b>	As many as qued
<b>Power:</b>	Lights (AUS Standard)
<b>Voltage:</b>	Lights (AUS Standard)
<b>Frequency:</b>	50/60 Hz 2%
<b>Transport:</b>	Trailer

# Ball Crawl

Our ASA Ball Crawl is an activity that will delight and amaze all children that play.

Of all our inflatable castles the Ball Crawl is undoubtedly the favorite being a place that children can swim in a sea balls, climb and speed down the slide, cross the bridge or dive through the tubes.

A huge 12m (x) 12m inflatable bouncy castle filled to knee level with soft plastic balls.

Contained by 2.5m inflatable walls, the Ball Crawl is a safe fun filled environment that includes 2 tubes, a mini bridge and an awesome bouncy castle slide.

This activity is a must for all events!



## Technical Specifications

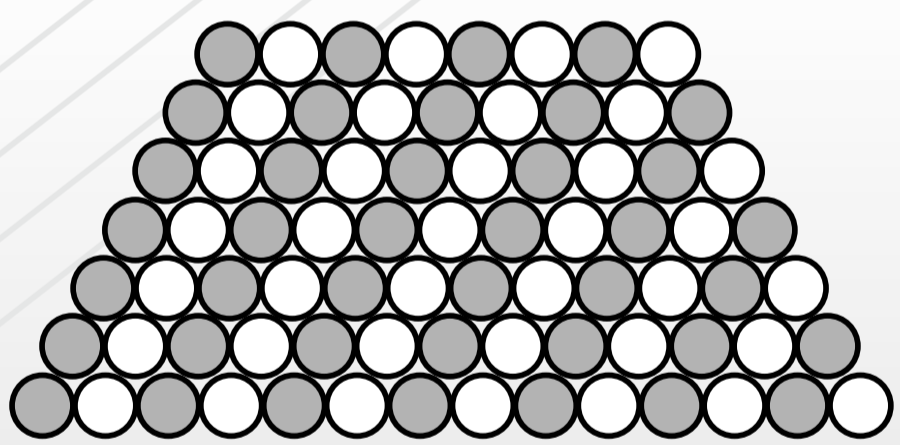

### ASA BALL CRAWL (12m x 12m)

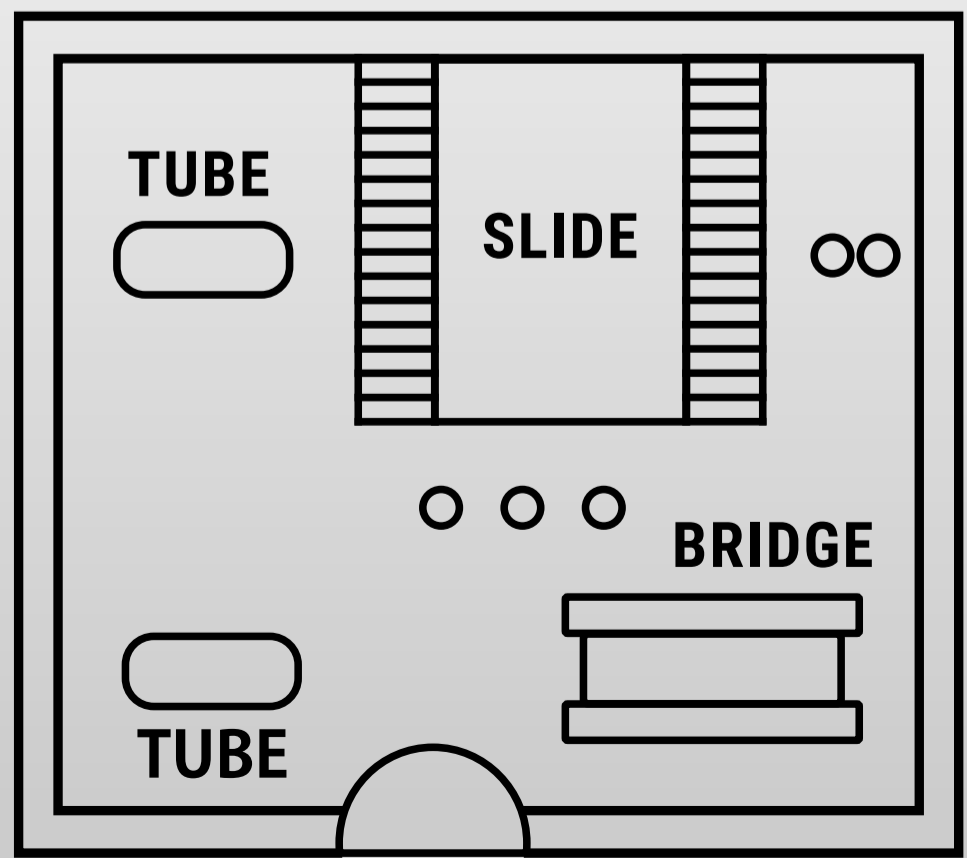

## Technical Specifications

<b>Year Of Manufacture:</b>	2016
<b>Country Of Manufacture:</b>	China
<b>Made By:</b>	General group
<b>Height:</b>	5 meters
<b>Dimensions:</b>	12m x 12m
<b>Pax:</b>	20 Pax at one Time
<b>Loading:</b>	Simultaneous
<b>Estimated Capacity:</b>	160 per hour
<b>Power:</b>	Lights (AUS Standard)
<b>Voltage:</b>	Lights (AUS Standard)
<b>Frequency:</b>	50/60 Hz 2%
<b>Transport:</b>	Trailer



# Dragon Wagon

The **ASA Dragon Wagon** is our premier children's ride, the ride most children instinctively gravitate to! An unconventional ride in the sense that it's speed and power are deceptively hidden until in action where it never fails to deliver squeals of delight and laughter to every rider, parents included!

The **Dragon Wagon is recognized** by it's distinctive dragon shape and vivid orange and green paintwork that while appearing fun and friendly also solicits awe & excitement from the young ones.

**and although the coaster** is quite small, set on an oval track having a single rise and fall which takes about two minutes to complete with 5 five laps (on average) to run, it is both exhilarating and safe!

## Technical Specifications

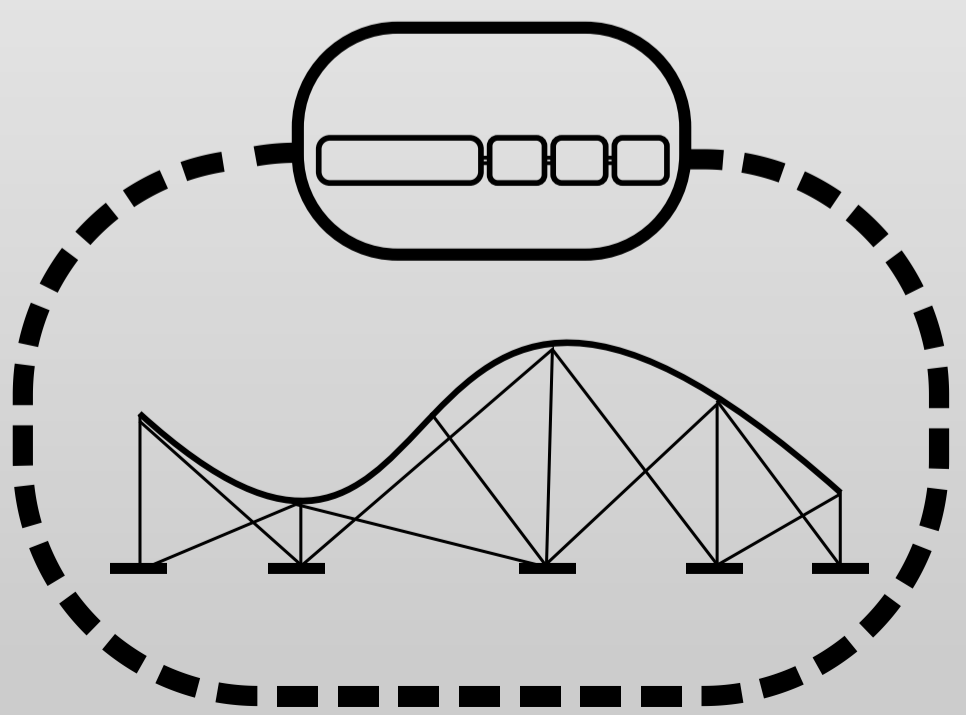
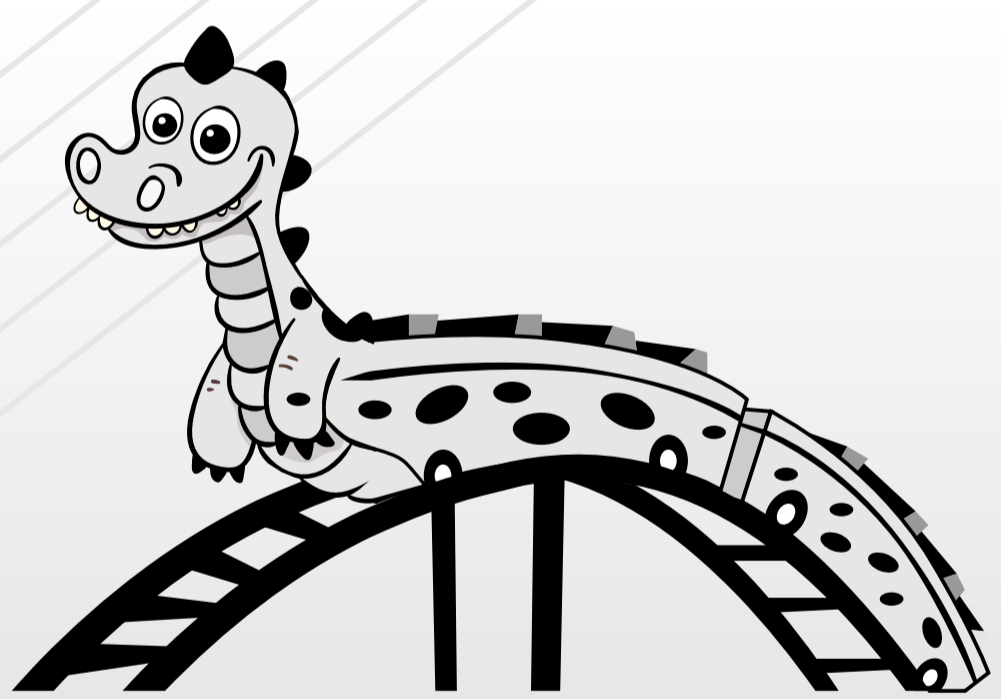

## Technical Specifications

<b>Year Of Manufacture:</b>	1990
<b>Country Of Manufacture:</b>	USA
<b>Made By:</b>	Wisdom
<b>Height:</b>	3 meters
<b>Lenght x Width x Height:</b>	15 x 8.5 x 6.5 meters
<b>Cars:</b>	8 carriages (16 PAX)
<b>Loading:</b>	Simultaneous
<b>Estimated Capacity:</b>	480 per hour
<b>Power:</b>	7 Kw
<b>Voltage:</b>	380v 5% 3 Phase + Neutral
<b>Frequency:</b>	50/60 Hz 2%
<b>Min Height + Age:</b>	90cm + 6 to Adult
<b>Transport:</b>	1x 13.6m Semi Trailer

# Super Planes

**ASA Super Planes** is an amusement ride intended for small children. It is usually presented as part of our **Kiddies Kingdom concept** however the ride can integrate with other attractions or stand alone amongst other children's rides.

It has been fully **refurbished and painted** in August 2019 with a fantastic retro artwork! The ride is always popular with the children because they will have the ability to move the plane up or down as it rotates in a clockwise direction

Each **vehicle loads 2 passengers** and elevates about 3 meters off the ground!

## Technical Specifications

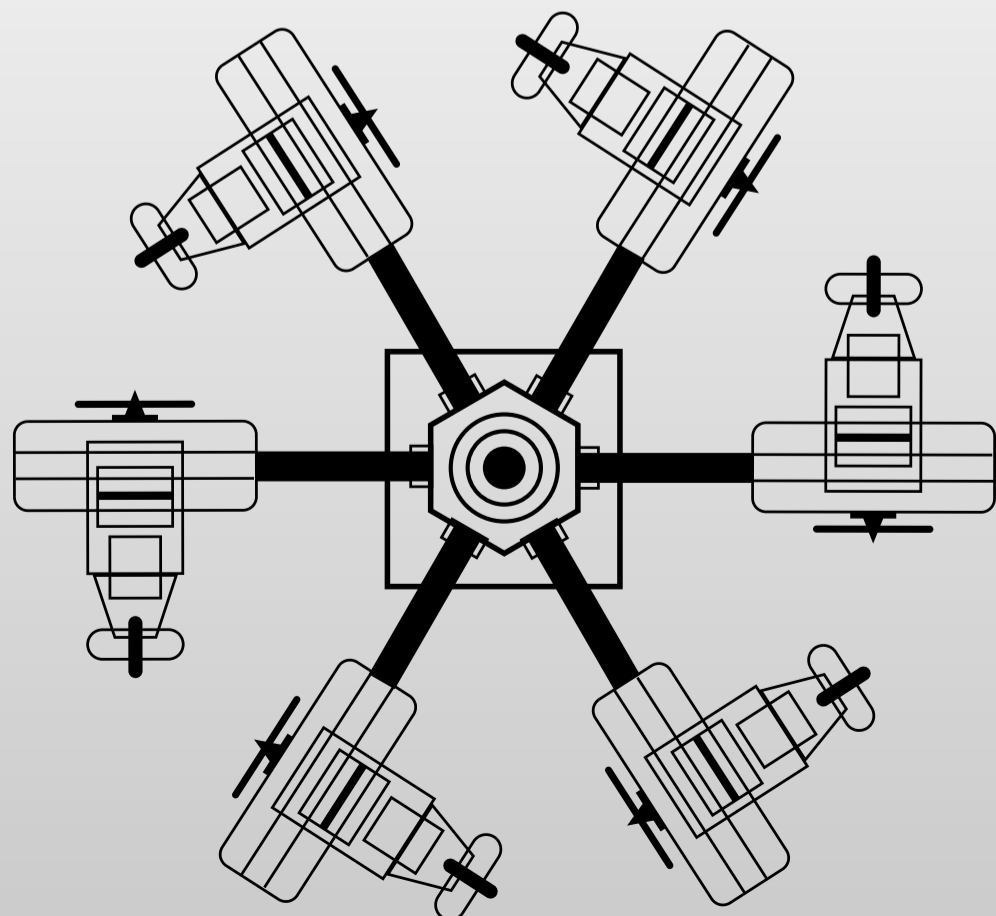

## Technical Specifications

<b>Year Of Manufacture:</b>	1989
<b>Country Of Manufacture:</b>	Italy
<b>Made By:</b>	Zamperla
<b>Height:</b>	3 meters
<b>Diameter:</b>	8 meters
<b>Gondalas:</b>	6 Planes*
<b>Loading:</b>	Simultaneous
<b>Estimated Capacity</b>	400 per hour
<b>Power</b>	7 Kw
<b>Voltage</b>	380v 5% 3 Phase + Neutral
<b>Frequency</b>	50/60 Hz 2%
<b>Transport:</b>	1x 13.6m Semi Trailer

\* 1 adult + 2 children or 3 children per plane

# Super Trucks

**Children will get double** the ride pleasure with our Super Trucks because each truck seat has it's very own steering wheel! Six magnificent 4x4 Super Trucks rotate around a small carousel where the little ones will experience the joy and excitement of being in control of their very own truck - just like the big boys!

Our ride was fully refurbished in 2018 for the 3rd Santa's Wonderland event held at the Adelaide showground.

and with nearly 50,000 patrons through the doors of the Goyder pavilion, **ASA's Super Trucks quickly proved** a family favourite. Their bright and colourful artwork along with their chrome finishing and flashing lights securing the vote!

## Technical Specifications

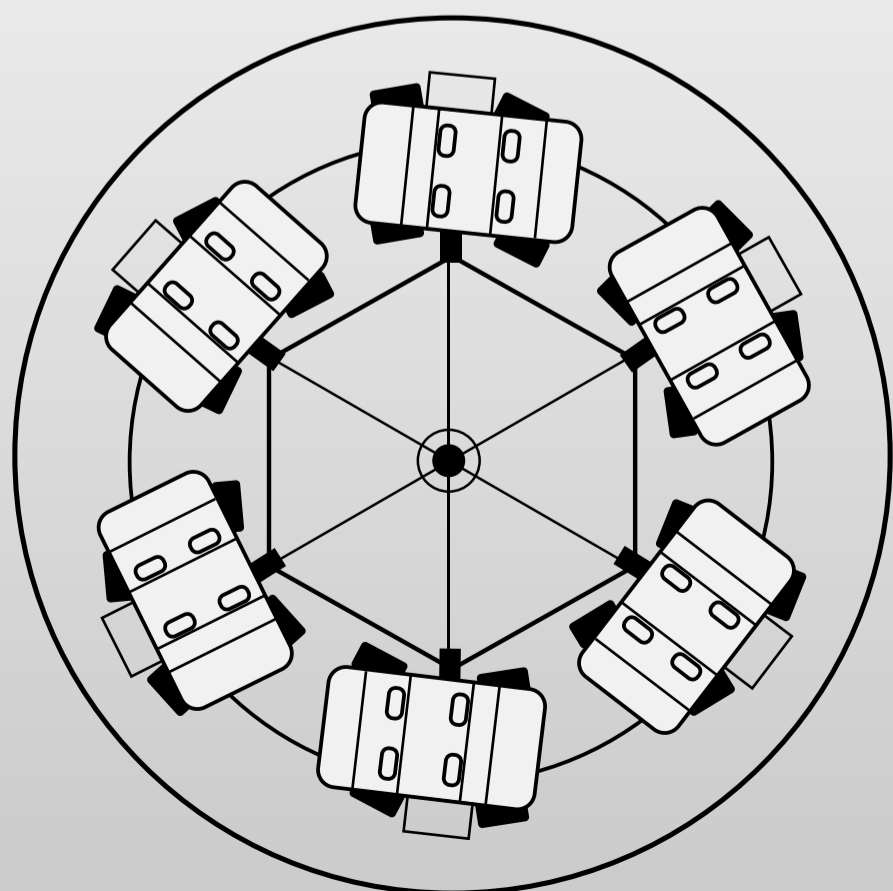

## Technical Specifications

<b>Year Of Manufacture:</b>	1999
<b>Country Of Manufacture:</b>	Italy
<b>Made By:</b>	SBF
<b>Height:</b>	2.5 meters
<b>Diameter:</b>	8 meters
<b>Gondalas:</b>	6 Trucks*
<b>Loading:</b>	Simultaneous
<b>Estimated Capacity</b>	400 per hour
<b>Power</b>	12 Kw
<b>Voltage</b>	210v 50a 3 Phase + Neutral
<b>Frequency</b>	50/60 Hz 2%
<b>Transport:</b>	1x 13.6m Semi Trailer

\* 4 children per Truck

# Motorbikes

ASA's **Hampton Motorcycle Ride** is our newest Children's acquisition and one of our most popular attractions featuring a variety of multi-colored, metal flake life size motorcycles capable of seating two passengers each.

Each motorcycle is equipped with a horn and flashing lights and as the ride rotates, the motorcycles go over a jump and also "pop a wheelie".

.... and those children riding pillion have their own handle bars, foot pedals and horn!

Our ride is the trailer mounted version which means that we can drive onto site and setup quickly and pull down just as fast in our bump in bump out periods.

# Technical Specifications

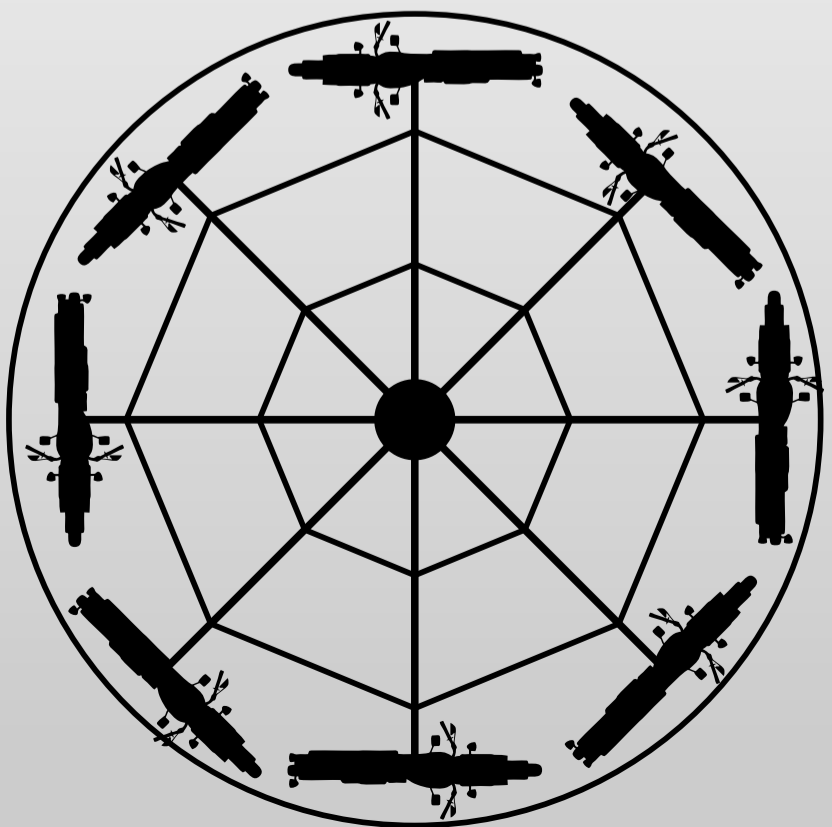
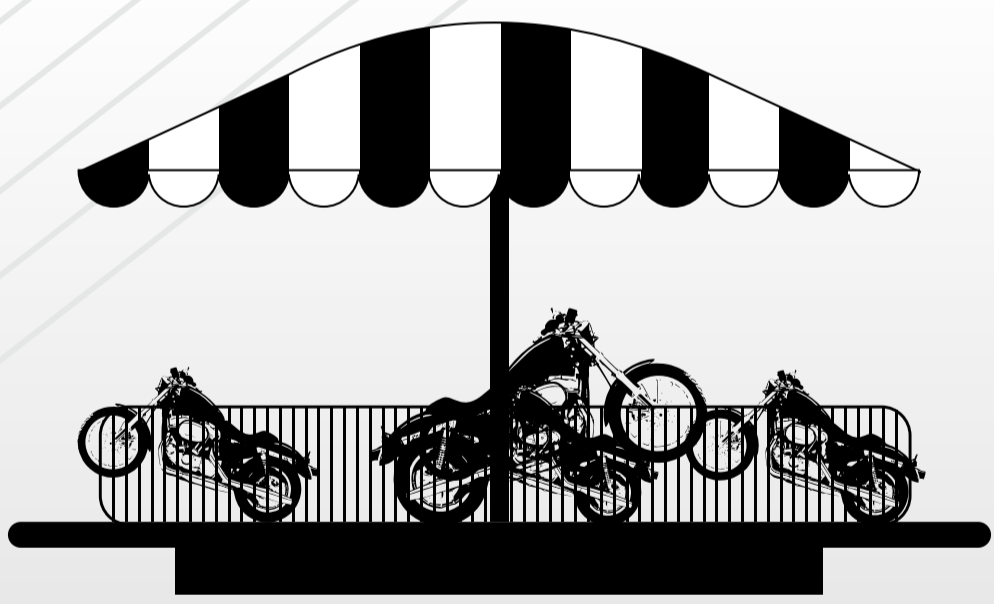

# Technical Specifications

<b>Year Of Manufacture:</b>	1993
<b>Country Of Manufacture:</b>	USA
<b>Made By:</b>	Hampton
<b>Height:</b>	3 meters
<b>Diameter:</b>	10 meters
<b>Gondalas:</b>	8 Motorbikes*
<b>Loading:</b>	Simultaneous
<b>Estimated Capacity</b>	350 per hour
<b>Power</b>	7 Kw
<b>Voltage</b>	380v 5% 3 Phase + Neutral
<b>Frequency</b>	50/60 Hz 2%
<b>Transport:</b>	1x 13.6m Semi Trailer

\* 2 children per motorbike

# Santa Fe Train

The Santa Fe Train is a beautifully crafted small children's ride that will amaze and delight all that ride her.

Designed and developed in accordance with the GB8408-2008 "safety of amusement and recreational facilities" and GB/T18165-2008 "small train type amusement machine general technical conditions."

The train has been designed for young children, 2 1/2 to 4 years old. It is safe, slow but authentic.

Older children can ride the Santa Fe train but they will have more fun riding our Super Planes or Dragon Wagon which are faster and more exciting.

## Technical Specifications

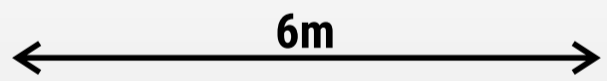
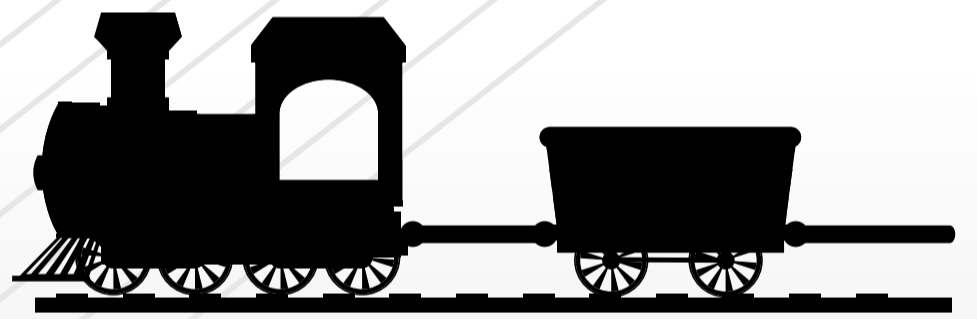

**Main Technical Parameters**

- Speed: 6.8km/h
- Rated load: 2000kg
- Total power: 2000w
- Seating Capacity:14 Riders
- Total weight: 900kg
- Track gauge: 500mm 4 Train Coaches
- Minimum turning radius: 3.6m
- Packing Volume: 38m<sup>3</sup>
- Dimensions: 2m in length, height 2.4m,1m width,

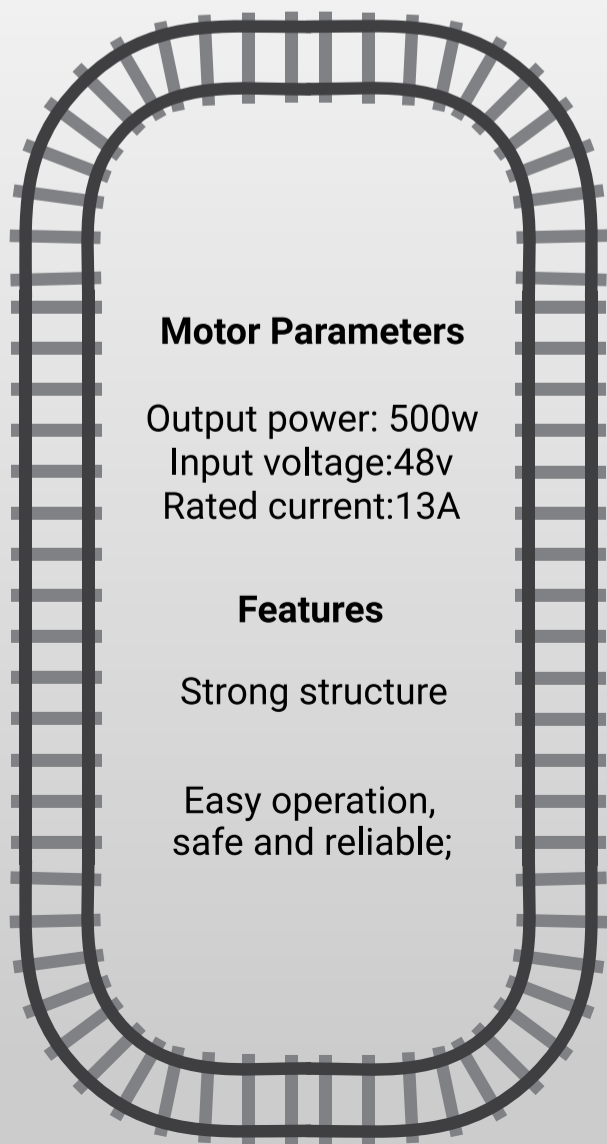

**Motor Parameters**

- Output power: 500w
- Input voltage:48v
- Rated current:13A

**Features**

- Strong structure
- Easy operation, safe and reliable;



## Technical Specifications

<b>Year Of Manufacture:</b>	2016
<b>Country Of Manufacture:</b>	China
<b>Made By:</b>	Modern Amusements
<b>Height:</b>	2.4 meters
<b>Dimensions:</b>	10m x 6m Track
<b>Gondalas:</b>	4 Carriages x 4 PAX
<b>Loading:</b>	Simultaneous
<b>Estimated Capacity</b>	350 per hour
<b>Power</b>	7 Kw
<b>Voltage</b>	380v 5% 3 Phase + Neutral
<b>Frequency</b>	50/60 Hz 2%
<b>Transport:</b>	1x 13.6m Semi Trailer

# Dodgem Cars

The Dodgem Cars has always been an Australian favourite!

These electrically powered vehicles favoured by families with older children and provide all the fun and thrills of a smash up derby!

Off course we don't allow head on bumping and all riders must drive in the same direction but jousting for position on the track will always be the lure of this ride!

ASA's Dodgem Cars are safe, fun and an activity that parents and children can participate in together!



# Technical Specifications

**Dodgen Car**

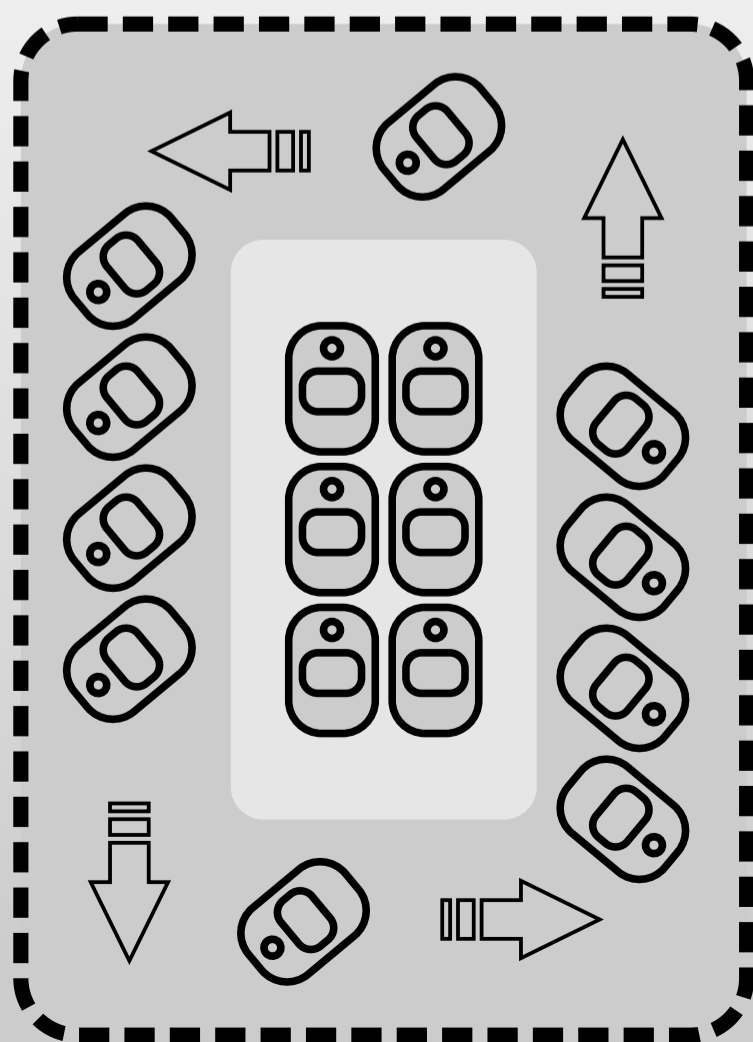
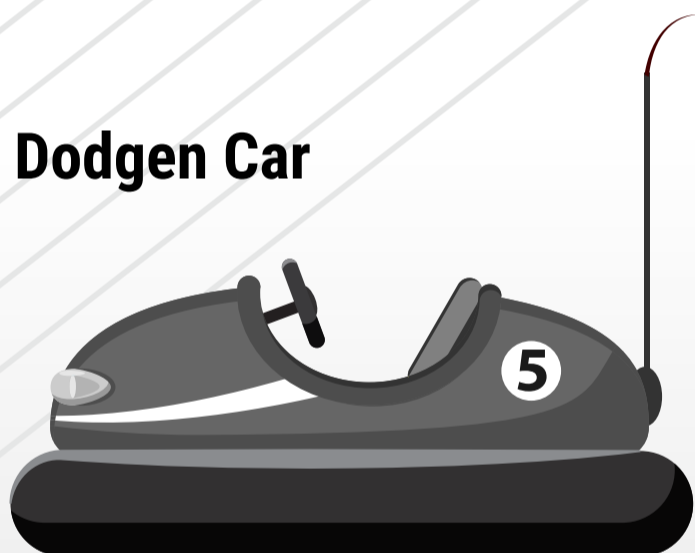

# Technical Specifications

<b>Year Of Manufacture:</b>	2002
<b>Country Of Manufacture:</b>	Australia
<b>Made By:</b>	ASA
<b>Height:</b>	4 meters
<b>Dimensions:</b>	10m x 15m Track
<b>Dodgen Cars:</b>	16 Cars 32 PAX
<b>Loading:</b>	Simultaneous
<b>Estimated Capacity</b>	350 per hour
<b>Power</b>	16 Kw
<b>Voltage</b>	380v 5% 3 Phase + Neutral
<b>Frequency</b>	50/60 Hz 2%
<b>Transport:</b>	1x 13.6m Semi Trailer

# Ocean Explorers

Join Kwazii, Barnacles and Peso as they explore the surface of the ocean in their Ocean Explorer speed boats rotating 360 degrees clockwise on our small boat pool.

Beautifully coloured boats riding on real water makes for an authentic children's experience.

Great fun for the toddlers and equally so for the watching parents!

A small compact ride that is completely safe with toddler friendly seat belts designed specifically for the adventurous 2 1/2 to 4 year olds. A great attraction for groups of parents with very young children!

## Technical Specifications

**Ocean Explorer Boat**

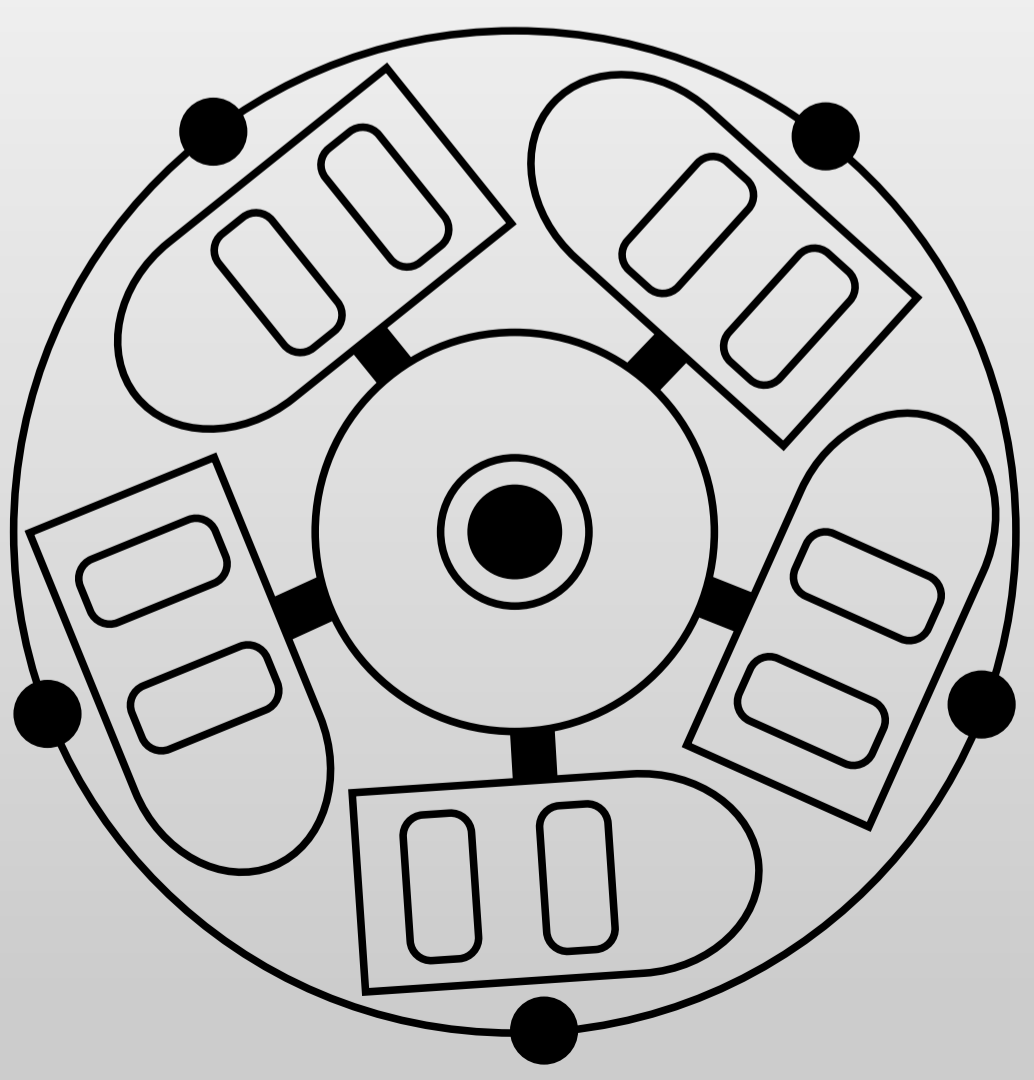
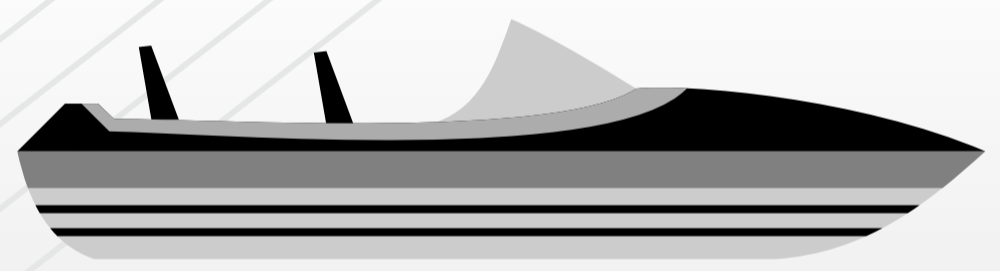

## Technical Specifications

<b>Year Of Manufacture:</b>	2010
<b>Country Of Manufacture:</b>	Australia
<b>Made By:</b>	ASA
<b>Height:</b>	5 meters
<b>Dimensions:</b>	5m x 5m Track
<b>Gondalas:</b>	5 Boats x 4 PAX = 20 PAX
<b>Loading:</b>	Simultaneous
<b>Estimated Capacity</b>	250 per hour
<b>Power</b>	2 Kw
<b>Voltage</b>	380v 5% 3 Phase + Neutral
<b>Frequency</b>	50/60 Hz 2%
<b>Transport:</b>	1x Small Trailer

# Tea Cups

ASA's Teacups is an amusement ride characterised by tea cup shaped spinning vehicles atop a turntable-like floor.

Based on the ride seen at major amusement parks the colorful cups spin around on their own axis as the whole ride turns.

This attraction has 6 cups each of which seats up to 4 children or 1 adult and 2 children. Parents can ride with the children.

Teacups can be enjoyed by the whole family, are safe, easy to set up and pull down and the colourful combination of lights, cups and swirling directions sure to please.

## Technical Specifications



**Spinning  
Teacups**

**8m x 8m**

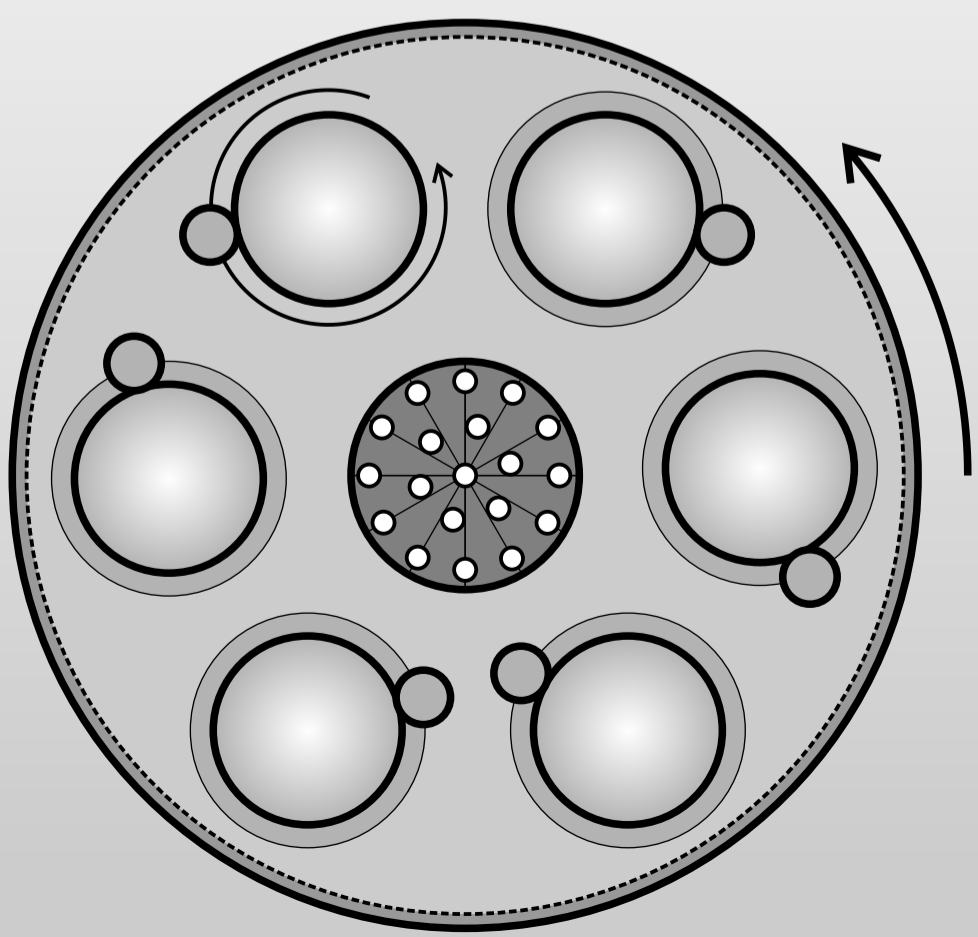

## Technical Specifications

<b>Year Of Manufacture:</b>	2016
<b>Country Of Manufacture:</b>	China
<b>Made By:</b>	Modern Amusements
<b>Height:</b>	3 meters
<b>Dimensions:</b>	8m x 8m
<b>Gondalas:</b>	6 Cups x 4 PAX
<b>Loading:</b>	Simultaneous
<b>Estimated Capacity</b>	300 per hour
<b>Power</b>	7 Kw
<b>Voltage</b>	380v 5% 3 Phase + Neutral
<b>Frequency</b>	50/60 Hz 2%
<b>Transport:</b>	1x Double Axel Trailer



# Waterballs

Our Waterballs are constructed with thermoplastic polyurethane (PVC) 0.7mm thick and 2m in diameter. They store flat, weigh 15kg each and can be inflated in under a minute with our air pumps.

They are 2m in diameter and have a zippered entrance to allow for easy entry and exit. The water ball is similar to the zorb, but it has only one layer and is designed for water travel rather than down-hill rolling. Our models have hand grips on the inside with our inflatable pool 8m by 5m in size filled to a maximum depth of 50cm.

We have multiple staff in attendance that are fully trained in CPR, vigilant and equipped to handle any or all emergencies that might arise. The pool is fenced off from the crowd on all sides in accordance to Australian safety requirements.

## Technical Specifications

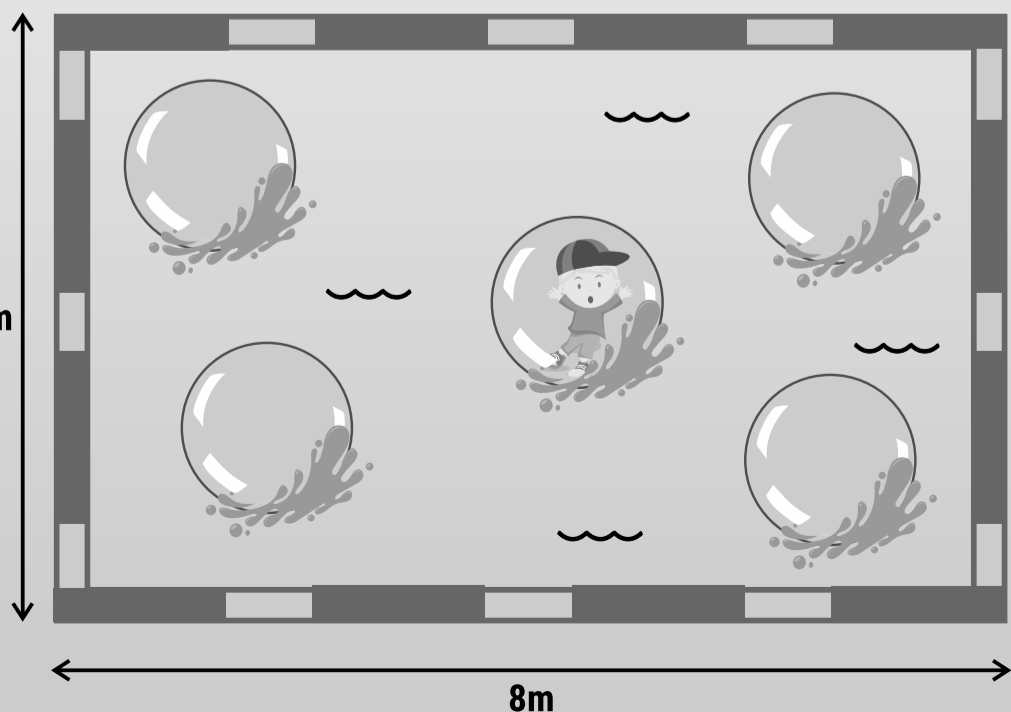

## Technical Specifications

<b>Year Of Manufacture:</b>	2016
<b>Country Of Manufacture:</b>	China
<b>Made By:</b>	General Group
<b>Height:</b>	2.5m Sail Covers
<b>Dimensions:</b>	8m x 5m
<b>Depth:</b>	50cm
<b>Loading:</b>	Simultaneous
<b>Estimated Capacity:</b>	120 per hour
<b>Voltage:</b>	240 Australian Standard
<b>Frequency</b>	50/60 Hz 2%

# Bungy Trampolines

ASA's Bungy Trampolines are a great way for children to experience the thrills of finding big air in a safe and controlled environment.

They are very easy to set up and offer hours of fun and exercise to all ages.

Bungy Trampolines are also a great way to pump up your event and your guests will love them!

Bungy Trampolines add an exciting visual element to any occasion while providing a fun, active and healthy activity that will ensure your guests will be talking about your event for a long time!

This is a favoured attraction for school fete's and smaller carnivals we organise.

## Technical Specifications

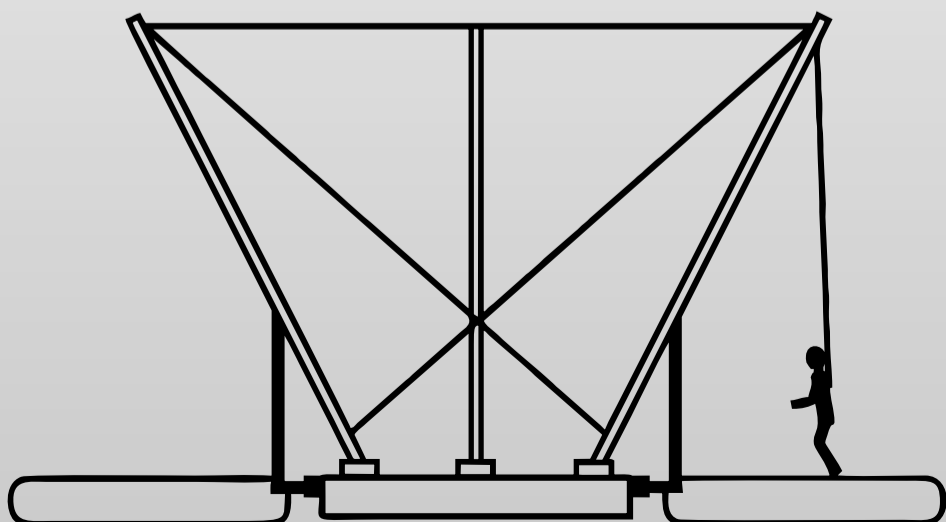
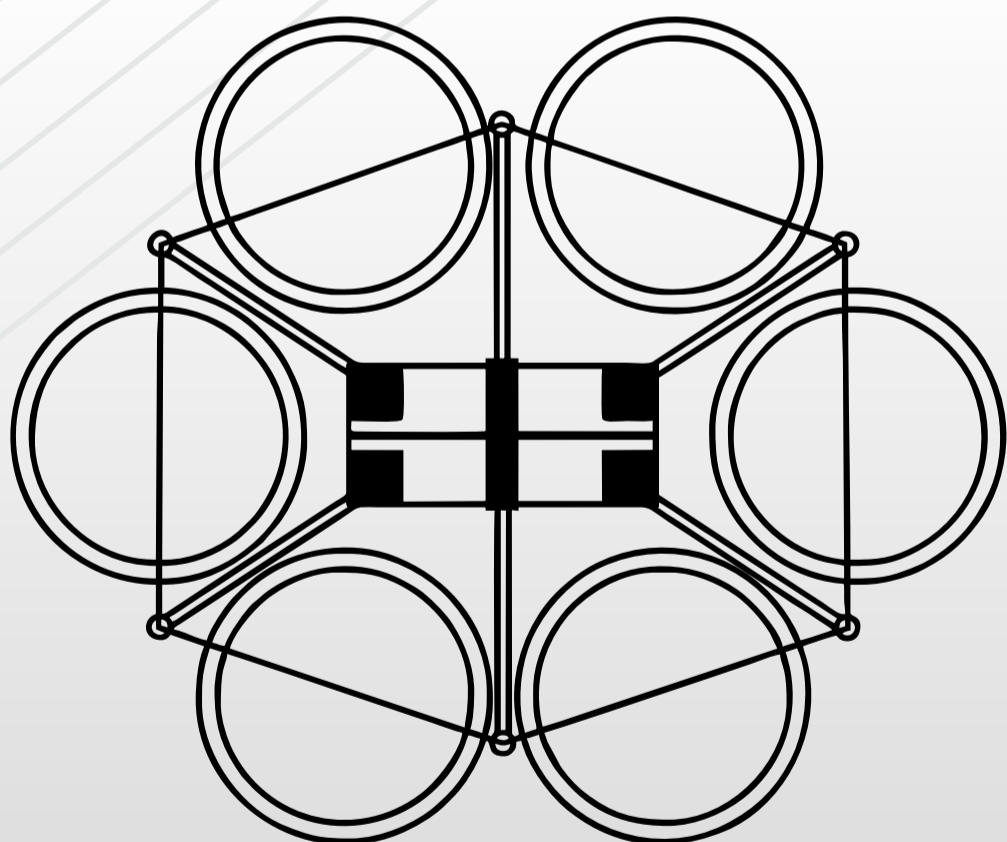

## Technical Specifications

<b>Year Of Manufacture:</b>	2012
<b>Country Of Manufacture:</b>	Australia
<b>Made By:</b>	ASA
<b>Height:</b>	7 meters
<b>Dimensions:</b>	12m x 9m
<b>Gondalas:</b>	6 Trampolines 6 PAX
<b>Loading:</b>	Simultaneous
<b>Estimated Capacity:</b>	72 per hour
<b>Power:</b>	Lights (AUS Standard)
<b>Voltage:</b>	Lights (AUS Standard)
<b>Frequency:</b>	50/60 Hz 2%
<b>Transport:</b>	Trailer

# Sea Circus Giant Slide

ASA's Giant Inflatable Slide is the ultimate in bouncy castle thrills and spills.

It reaches up a massive 12m to literally touch the sky above haha ;)

Well maybe not that high but high enough to be the ultimate inflatable slide ride.

This bouncy castle is a sure fire winner at any event and will leave your children exhausted as they climb and slide time and time again.

It's also very safe, fun and exhilarating for the younger ones who need a soft landing to protect their youthful urges to climb high!

## Technical Specifications

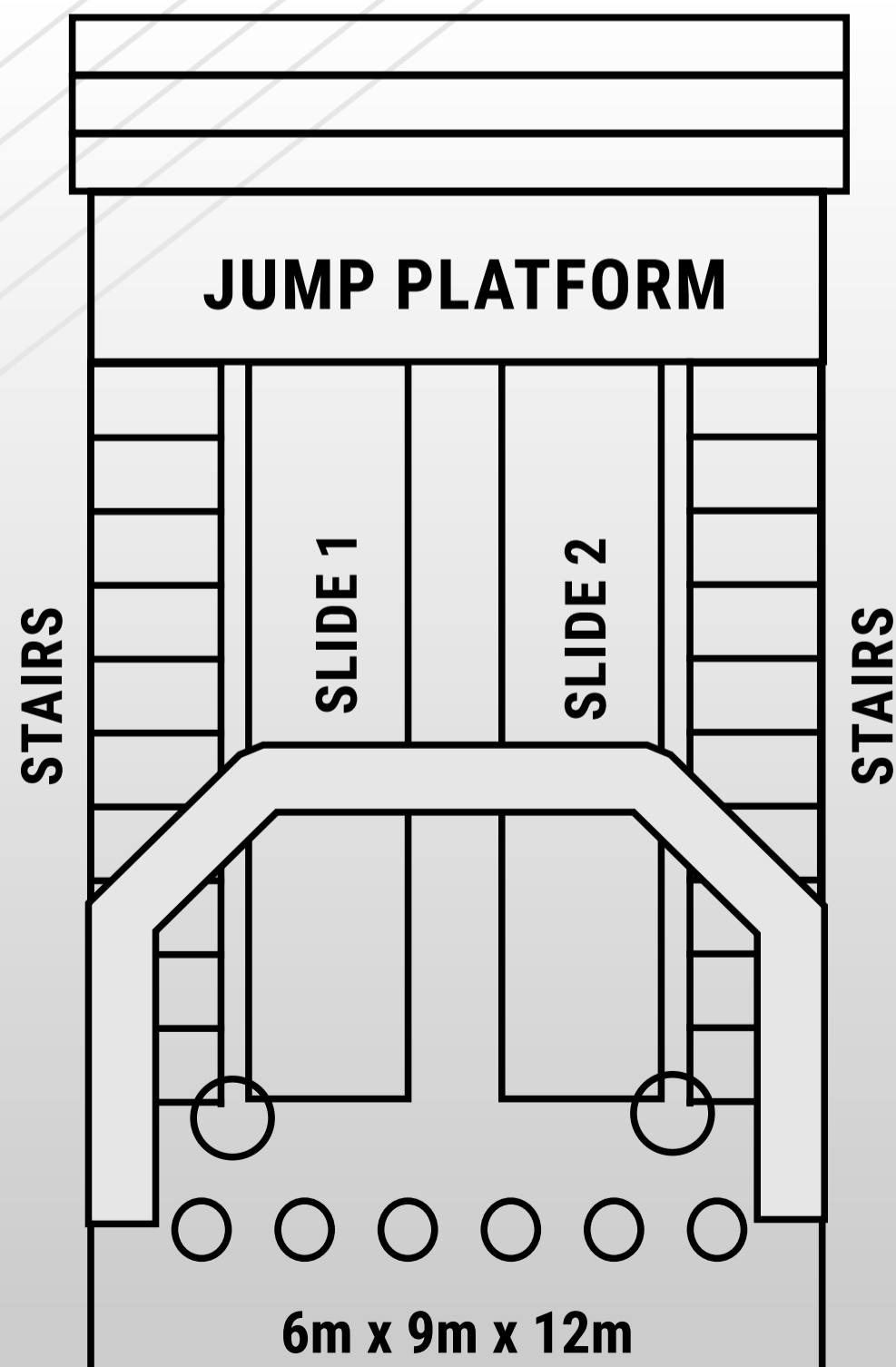

## Technical Specifications

<b>Year Of Manufacture:</b>	2016
<b>Country Of Manufacture:</b>	China
<b>Made By:</b>	General Group
<b>Height:</b>	12 meters
<b>Dimensions:</b>	6m x 9m
<b>PAX:</b>	12 PAX at one time
<b>Loading:</b>	Simultaneous
<b>Estimated Capacity:</b>	150 per hour
<b>Power:</b>	Lights (AUS Standard)
<b>Voltage:</b>	Lights (AUS Standard)
<b>Frequency:</b>	50/60 Hz 2%
<b>Transport:</b>	Standard Car Trailer

# Candyland Jumping Castle 1

ASA owns a number of Bouncy Castles including our newly purchased Candyland Inflatables.

These were first featured in our very successful Santa's Wonderland Christmas extravaganza held in the Adelaide Showground Goyder Pavilion in Dec 2016.

Bouncy or Jumping Castles are always a big favourite with the Children and ours are bright, colourful and no stranger to laughter and squeals of delight!

The castles to the right are always a mainstay in Santa's Wonderland Adelaide and is always a big crowd favourite.



## Technical Specifications

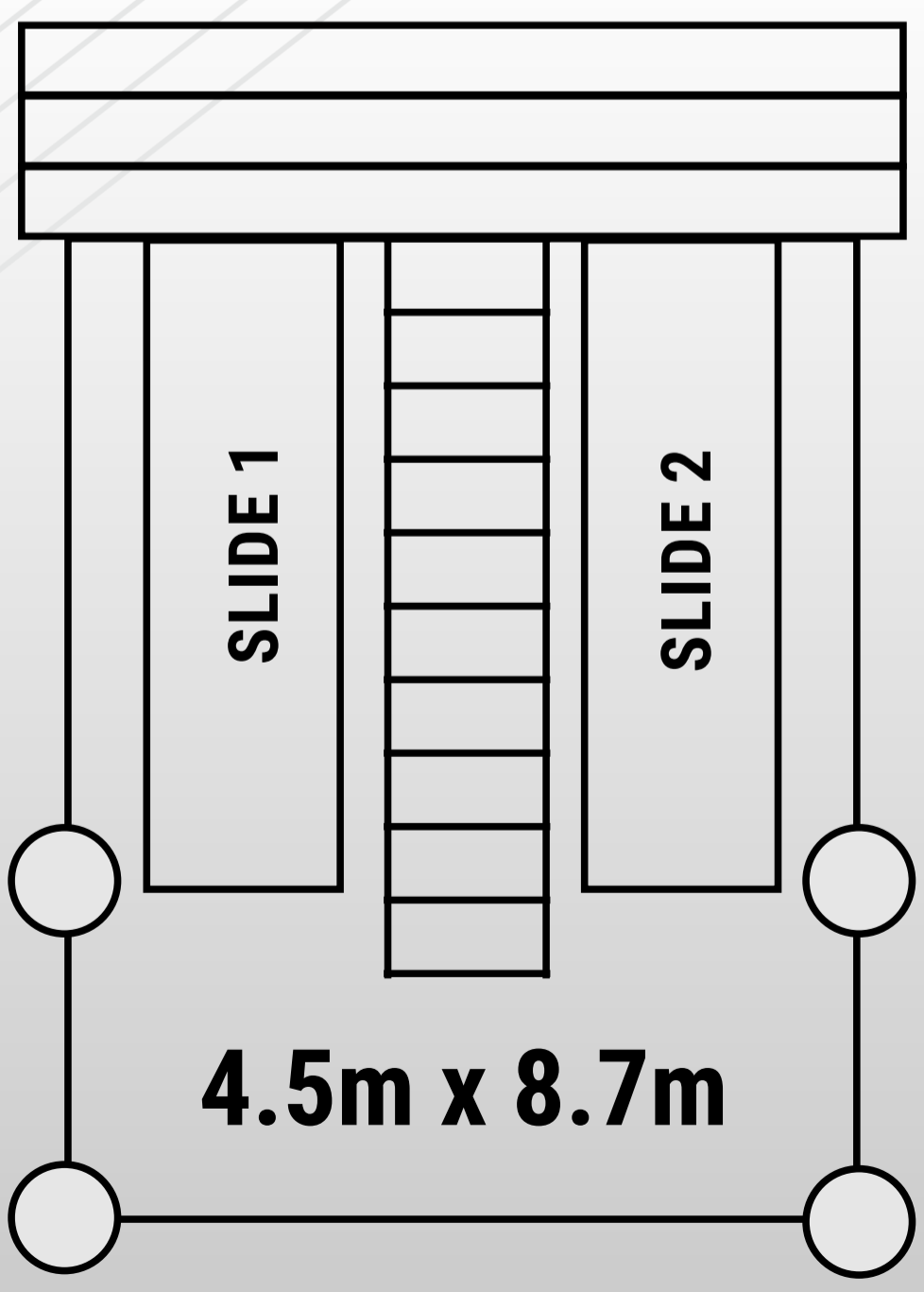

## Technical Specifications

- Year Of Manufacture:** 2016
- Country Of Manufacture:** China
- Made By:** General Group
- Height:** 5.8 meters
- Dimensions:** 4.5m x 8.7m
- PAX:** 12 Children at one Time
- Loading:** Simultaneous
- Estimated Capacity:** 150 per hour
- Power:** Lights (AUS Standard)
- Voltage:** Lights (AUS Standard)
- Frequency:** 50/60 Hz 2%
- Transport:** Standard Car Trailer

## Candyland Jumping Castle 2

ASA owns a number of Bouncy Castles including our newly purchased Candyland Inflatables. These were first featured in our very successful Santa's Wonderland Christmas extravaganza held in the Adelaide Showground Goyder Pavilion in Dec 2016.

Bouncy or Jumping Castles are always a big favourite with the Children and ours are bright, colourful and no stranger to laughter and squeals of delight! The castles to the right are always a mainstay in Santa's Wonderland Adelaide and is always a big crowd favourite.

## Technical Specifications

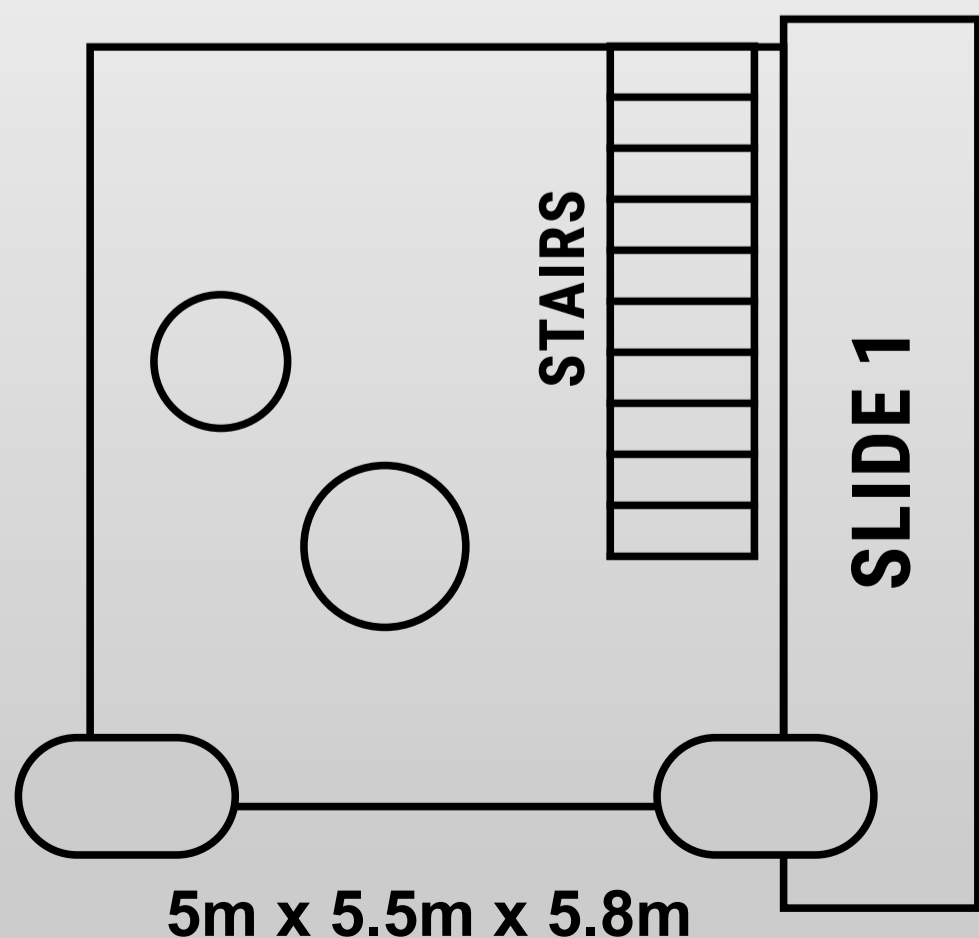
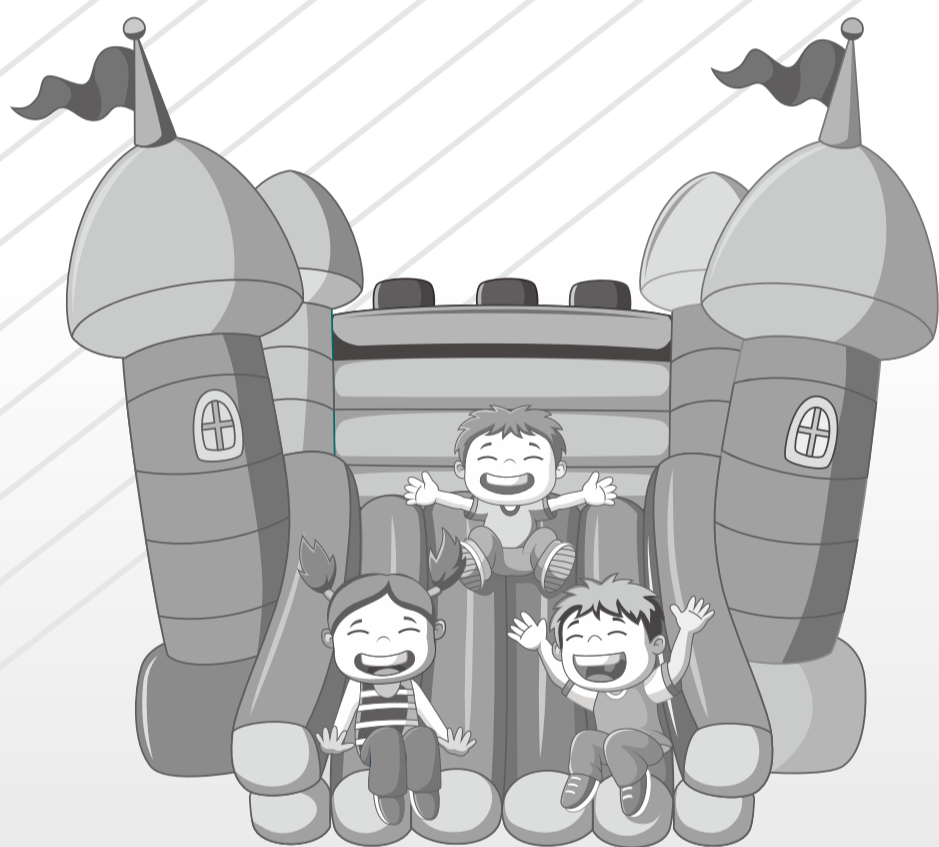

## Technical Specifications

<b>Year Of Manufacture:</b>	2016
<b>Country Of Manufacture:</b>	China
<b>Made By:</b>	General Group
<b>Height:</b>	5.8 meters
<b>Dimensions:</b>	5m x 5.5m
<b>PAX:</b>	12 Children at one Time
<b>Loading:</b>	Simultaneous
<b>Estimated Capacity:</b>	150 per hour
<b>Power:</b>	Lights (AUS Standard)
<b>Voltage:</b>	Lights (AUS Standard)
<b>Frequency:</b>	50/60 Hz 2%
<b>Transport:</b>	Standard Car Trailer

# Mini Quad Dirt Bikes

ASA own and operate Mini Quad Motorbikes to allow the young ones to experience first hand what it is like to ride a motorbike.

All riders will be provided with Helmets that meet Australian ISO Standards and instructed to obey the track controller at all times.

The track controller will only permit riders to ride in one direction around the track, with no wheelies or mono's being permitted, cutting off other riders or intentionally checking other riders quads.

Our Mini Quad Dirt Bikes are entry level four-stroke ATV's that are ideal for riders starting in the sport. With an emphasis on safety and adult control, our Quads feature a throttle limiter to control engine output, a tether switch to remotely shut off the ignition, and a keyed main switch that prevents unauthorized use.

Adjustable hand controls, an automatic transmission, full floorboards, and a low seat height make sure that beginning riders (age 6 and older) will enjoy active convenience and control.

To sum it up, our Mini Quads are packed with quality, safety and style making it the perfect choice for young adventurers!



**ASA  
Mini Quads**



# Giant Worm

ASA's giant inflatable worm is a favourite with all kids 5 years and up.

Kids enter, bounce and play as they make there way through our 30m tunnel.

Stairs, windows, slides, soft obstacles, soft landings and an abundance of colour keep them active, happy and entertained!

## Technical Specifications

- Type:** Tunnel
- Material:** Vinyl
- Place of Origin:** Guangdong, China
- Brand Name:** Toys-Ocean
- Model Number:** W-1069
- Colour:** All Colour
- Size:** 30m
- Warranty:** 3 Years Warranty
- Material:** 0.55mm PVC Vinyl Tarpaulin
- Sewing:** Double Stitched 4 Fold
- Blower:** CE, UL, 220V, 110V 50/60HZ
- Certificate:** CE, EN14960, EN71-2-3, M2
- Type:** Bounce With Slide
- Accessories:** Portable Repair Kit

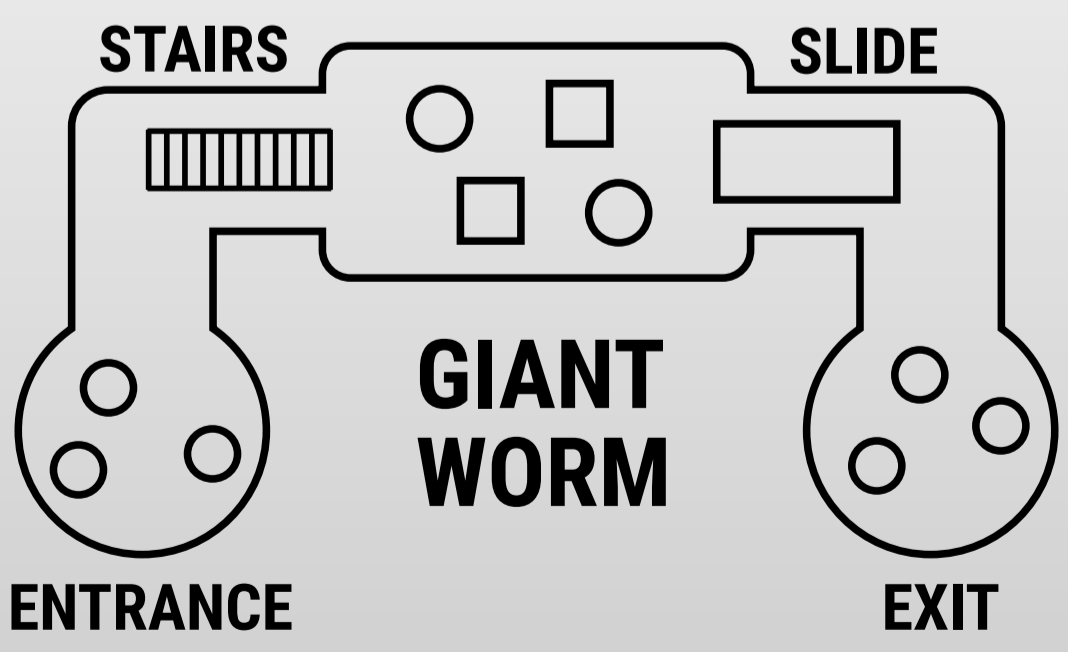

## 30m of Inflatable Tunnel

# Shark Jumping Castle

Amusement Services Australia multiplay shark jumping castle is the most popular in our range. It is designed in bright, fun colors with neat animations and a cool shark theme. This makes for a great eye-catcher!

Furthermore, the multiplay bouncer is very comprehensive and provides hours of fun.

In the jump area there are many obstacles where children can bounce, jump around and play. There is also a slide incorporated in the inflatable to complete the total look.

The cool shark situated on the front is a real eye-catcher. In addition, the multiplay inflatables are suitable for every child.

## Technical Specifications

**Dimensions:** 5.4m x 5m x 3.0m (L x W x H)

**Packed Size:** 1m x 1.2m

**Weight:** 150 kg

**Blower:** 15 kg

**Set up Time:** 10 minutes

**Install, Pack Up:** 1-2 persons

**Capacity:** 12 persons

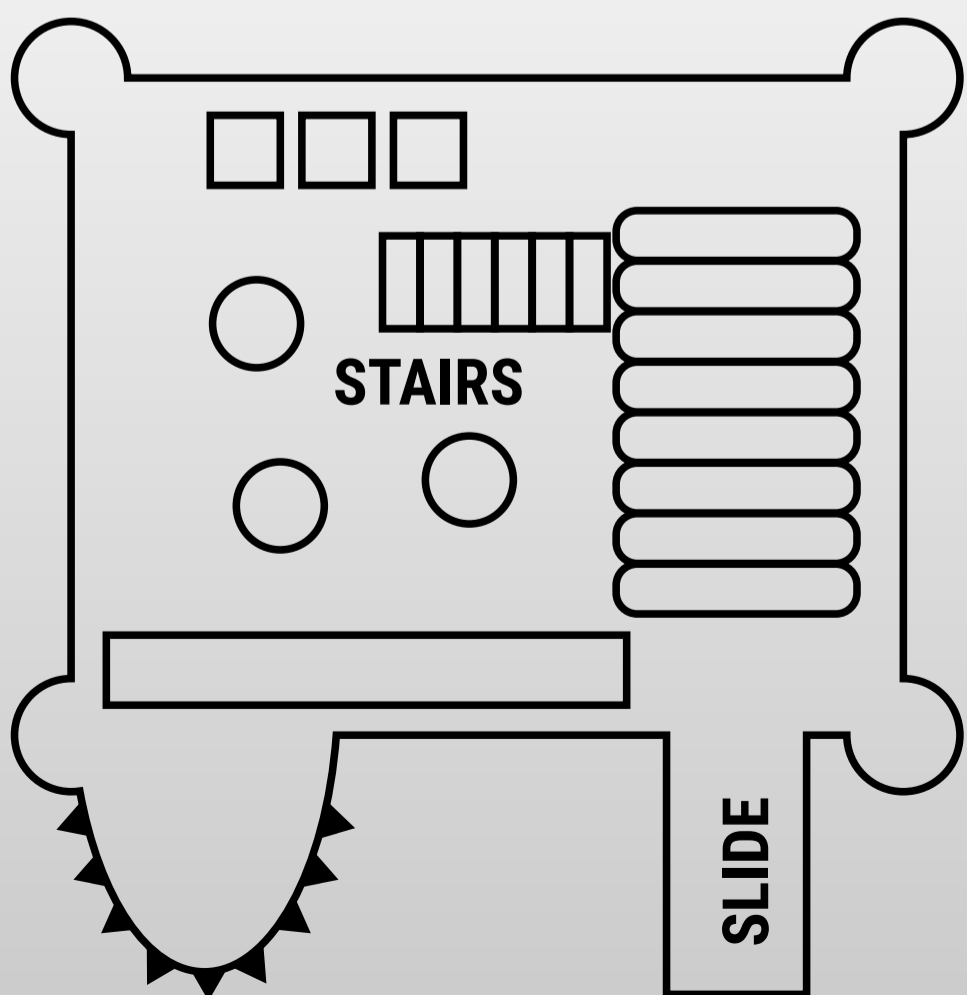



# Cartoon Network Pick a Pop

ASA's **Cartoon Network Pick a Pop** game is a new spin on our old favourite "Catch a Character" but instead of hooking pop characters floating in a pool, our Cartoon Network pop characters are placed on top of prizes that sit on a spinning table.

Once **you Catch 3 Characters** with your hook the number underneath your character (which equals either 6,7,8,9,10, 20, 30, 50 or 100) is combined with your other catch numbers to denote the prize you win!

- **Catch 3 for \$10**
- **Catch 7 for \$20**



## Number System

- 000-045 points** = Wins a small Consolation prize
- 046-065 points** = Wins a Size 1 plush toy
- 066-085 points** = Wins a Size 3 plush toy
- 086-105 points** = Wins a Size 5 plush toy
- 106-125 points** = Wins a Size 6 plush toy



In ASA's Cartoon Network Pick a Pop game every player **wins a licensed prize** with all game versions complimented by music and tapes that explain the game rules.



**Cartoon Network Plush Prizes from Benson's**



Sonic, Super Mario, Pacman & Halo Pop Characters (like the ones above) are placed on top of boxed plush prizes which sit on top of a rotating table inside a 5m x 5m centre tent.

Each Player uses a hook to catch the pop character of their choice as the table rotates slowly past!



**Rotating Table** →  
inside our 5m x 5m centre tent

# Shopkin's Catch a Character

ASA's Shopkins Catch a Character game is a family favourite where players use a hook to "Catch a Character" floating in a square pool located underneath a 5m x 5m centre tent.

Once **you Catch 3 Characters** with your hook the number underneath your character (which ranges between 5 and 10) is combined with your other catch numbers to denote the prize you win!

For a **\$5 game play** you can score anywhere from 15 to 30 points **AND if you want, you can opt to play again** and add those scores together to win bigger prizes!

In ASA's Shopkin's Catch a Character game every player **wins a licensed prize** with all game versions complimented by music and tapes that explain the game rules.

We also have **5 characters floating in the tank** at all times that have "**Pick Of The Prizes**" written on them. Hook one of these and choose any prize!

## Number System

**001-020 points** = a Novelty Prize

**021-040 points** = a Tiny Inflatable Prize

**041-060 points** = a Small Plush Size 20cm

**061-080 points** = a Medium Plush Size 30cm

**081-100 points** = a Large Plush Size 40cm

**101-120 points** = a Giant Plush Size 60cm



**VOTED BEST GAME** in SHOW Adelaide 2018!

# Adventure Time Ring a Bottle

ASA's Adventure Time Ring a Bottle game is fun for the whole family.

The way the game works is simple. **You purchase rings which** are thrown at a **square grid of bottles**. If you can lodge the ring on the neck of a bottle you win a prize.

Where the bottle is placed in the grid, ie along the out edge or closer to the centre **determines the prize you win**.

**The bottles around** the outside represent novelty prizes, further inside the grid the bottles represent tiny, small, medium, large and finally in the centre of the the grid, giant prizes!

The four roof quarters of this centre tent are covered in **Adventure Time artwork** and the prizes are only licensed Adventure Time merchandise.

**Every player will win a licensed prize** for a \$5 play with all game versions complimented by music and tapes that explain the game rules.

## Game Play

**\$5 for 5 Rings**  
**or \$10 for a Bucket of Rings**



**Benson's Trading** Licensed Plush Prizes



# Laughing Clowns

The Laughing Clowns are one of Australia's most popular sideshow games where players have fun and receive a prize each time!

Our version of this game has been tailored to include a children's platform for parents with small children and toddlers so people of all ages can enjoy the game experience.

The Laughing Clown game is 8m wide, 3 meters deep and 5 meters high and you only win licensed prizes from Benson's Trading Company playing this game.

Just place 5 balls into the clowns mouth and attempt to line up any of the prize winning scores displayed on the backdrop. It's simple to play and easy to win. All you need to do is add up your score to see which prize you win.



Plush Toys  
Shopkins, Octonauts  
Adventure Time  
TMNT & Paw Patrol

## Prizes

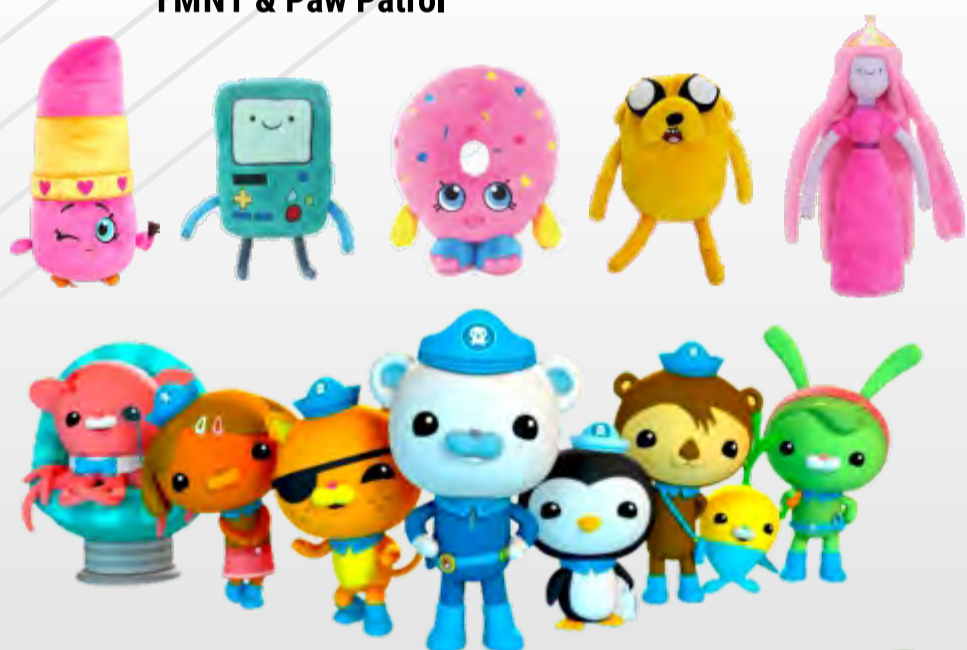

Prize Sizes  
Giant 60cm  
Large 40cm  
Medium 30cm  
Small 20cm



# Bazooka Blast

Our Ben 10 Bazooka Blast is a nurf ball game that fires soft nerf projectiles at various Ben 10 alupanel characters that move along mechanical tracks.

Shooting gallery games have always been favoured by kids and our licenced cartoon network Ben 10 theme will attract a large participation from young families and older kids alike.

Our staff are fully trained in how to safely manage shooters and our nerf ball bazooka's. In fact safety is paramount to us and as such, all shooters will be required to wear safety glasses as well as parents and friends that support or stand next to them.

ASA has prepared special line tents which will allow our Ben 10 Bazooka Blast game to be set up as either a 5m or 10m front complimented by music and tapes that explain the game rules, prizes and characters.

For every \$5 or \$10 play if you fail to shoot down any targets you receive a token licenced prize. The more you knock over the bigger the prize. 2 over wins a novelty prize, 4 over an inflatable prize, 6 over a small plush prize, 8 over a medium plush prize, 10 over a giant plush prize. You can play again to add scores from your first game to your second or third game to keep going for bigger prizes!

## Prizes

Ben 10  
PLUSH TOYS

Giant 60cm  
Large 40cm  
Medium 30cm  
Small 20cm

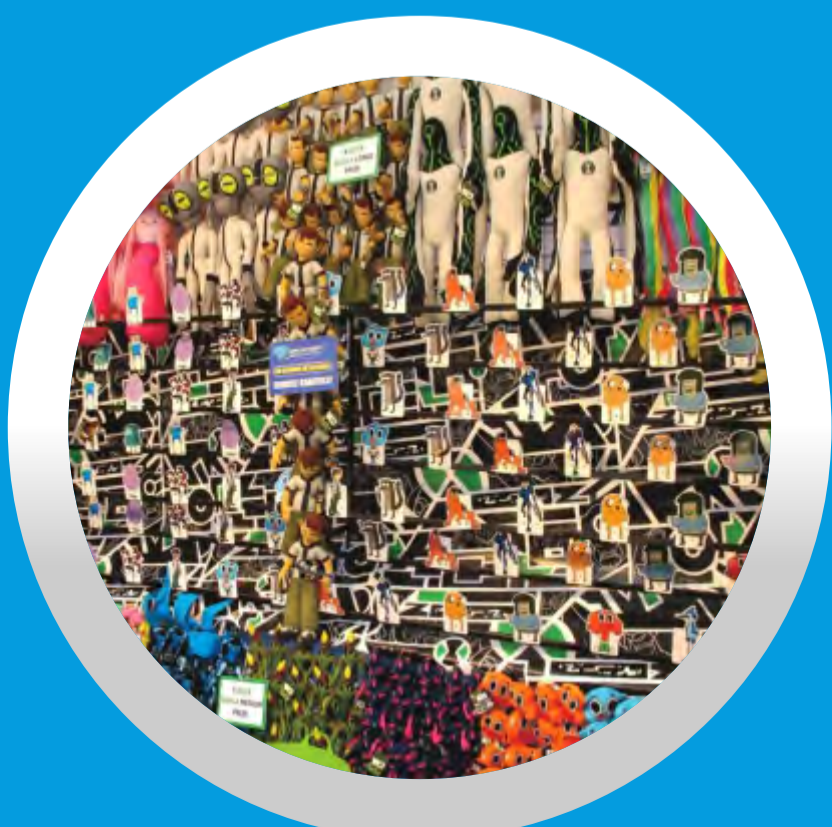

# Safety Officer



**Russell Watkins** is the nominated Safety Officer for any of our events & has qualifications in OHS along with 20 years experience in the set up of amusement devices on a national level. **His duties encompass:**

- Ensuring that the site is safe from hazards,
- Correctly storing hazardous materials,
- Enforcing ASA's **No Alcohol** policy on site,
- Testing & Tagging all electrical cables,
- The erecting and checking of all safety barriers,
- Conducting emergency procedure briefings,
- Maintaining all fire equipment, and
- Ensuring all ride safety signs are displayed.

**Russell Watkins** holds a current high risk work licence from **Safework VIC** that includes: Working at Heights, Crane Operator, Construction White Card, Forklift License & MC Truck License.

# First Aid



**Amanda Watkins** (a qualified senior first aid provider) is our **nominated First Aid provider** on site. She also conducts refresher courses for our permanent staff and ensures that all our casual employees have first aid training.

# Accreditations



ASA is insured by **CoverSure** for **20,000,000++**, Work Safe Victoria compliant, Test and Tag compliant and all permanent staff members have Working with Children clearance.

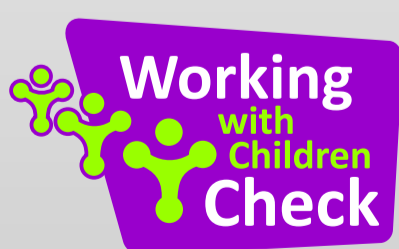

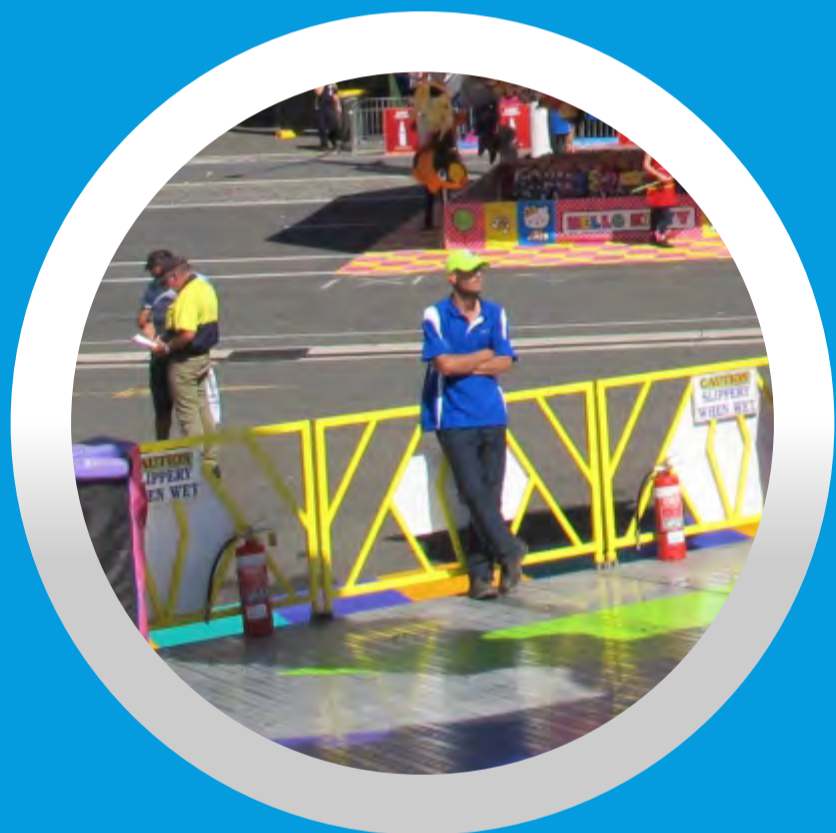

## Uniforms & Presentation

**ASA recognizes** the importance our team member's contribute to the success of an event.

**We are dedicated to providing** thorough training to all team members to arm them with the knowledge & confidence they need to handle any situation in the execution of your role as a carnival ride or games attendant.

They are on the **front line of ASA operations** and as such their actions reflect directly on our reputation.



### **Standard ASA Uniform**

Blue Polo Neck Shirt with ASA Logo  
Baseball Cap with ASA Logo  
Black or Dark Navy Blue Trousers

**It is vital to us that** they maintain a professional, positive attitude towards the position they have been selected for.

A friendly outgoing personality towards customers is important as **ASA strives to provide a family friendly** experience every time our patrons board one of our rides or participate in one of our games.

# Revenue Tracking

Any modern company needs to track it's income, especially if it comes from multiple games, rides and activities. At ASA we use VEND which is a **seamless cloud based POS** system that allows us to make sales anytime, anywhere.

**All Ride and Game sales** will be recorded through our VEND Point of Sale System. We will be able to provide **comprehensive statistics** on income, prizes, time & plays from our game stations. Any Query is possible on VEND!

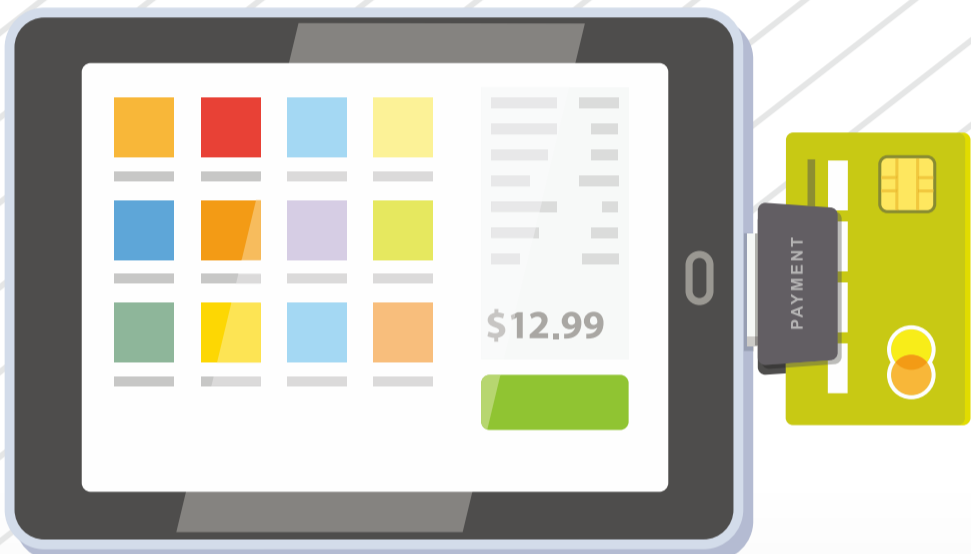

## Contact Us



You can contact **ASA Monday to Friday** between 9am and 5pm on the below given mobile numbers or you can send us an email through our contact form located on our website.

## Russell or Amanda Watkins

Amusement Services Australia

[www.amusementsservicesaustralia.com](http://www.amusementsservicesaustralia.com)

PO Box 1072, Cowes, VIC, 3922

**Tel1:** 041 7674 266 **Tel2:** 045 1265 597

